

Castors, Legs & Glides



- high quality furniture fittings



The technical descriptions and dimensions in this catalogue, also those with the photographs and drawings, are not binding. We reserve the right to make design improvements.

We bear no liability for any misprints or other errors that might occur in the production of the catalogue.

SISO A/S tager forbehold for trykfejl samt ændringer i produktets specifikationer.

Für Druckfehler und Irrtümer ist jede Haftung ausgeschlossen. Produktänderungen behalten wir uns vor.



- high quality furniture fittings

SISO A/S
MILEPARKEN 11
DK - 2740 SKOVLUNDE
(COPENHAGEN)
DENMARK
PHONE: (+45) 45 830 900
FAX: (+45) 45 830 444

DISTRIBUTOR









CONTENTS

- high quality furniture fittings



CONTENTS	3-4
TWIN WHEEL CASTOR	5-11
TEA TROLLEY CASTOR "FORCELLA"	12
FORK CASTOR W/TOP PLATE & TRANSPARENT PU WHEEL	13-14
BOX CASTOR	15-17
BRASS CASTOR "BRASCELLA"	18
FORK CASTOR "GARDA" - Ø76 MM - PLASTIC	19
FORK CASTOR W/TOP PL. & PU TRACK - STEEL	20
FORK CASTOR W/TOP PL. & RUBBER TRACK - STEEL	21-25
INDUSTRIAL FORK CASTOR W/SWIVEL TOP PL.	26
ALU LEGS	28-29
ZAMAK LEGS	30
STEEL LEGS	31-32
TABLE METAL LEGS W/HEIGHT ADJUSTER	33
ADJUSTABLE GLIDES	34-44
PANEL SHOES	45



NAIL-ON GLIDES	46-47	
NAIL-ON & KNOCK-IN GLIDES	48	
KNOCK-IN GLIDES & FELT PADS	49	
BUMBER DISCS & SUCTION PADS	50	
SUCTION PADS	51	
WASHERS & SPACERS	52	
INSERT GLIDES	53-56	
TUBE SLIDES	57-58	

TWIN WHEEL CASTOR W/TOP PLATE

- high quality furniture fittings



TWIN WHEEL CASTOR W/TOP PLATE

Material: Wheel: Polyamid (PA), black.
Top plate: 2 mm steel, bright zinc plated.

Application: Premounted top plate 42 x 42 mm or
38 x 38 mm.

With or without brake.



No brake



mm

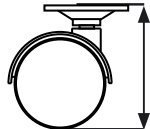

mm

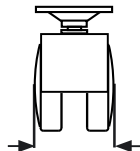

mm



static
kg

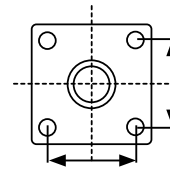

mm

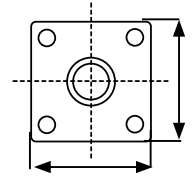

mm

08.04.003

30

43

32

15

27 x 27

38 x 38 x 2

08.04.029

40

56

41

25

32 x 32

42 x 42 x 2

08.04.097

50

64

47

30

32 x 32

42 x 42 x 2



With brake



mm

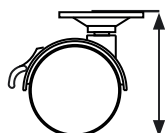

mm

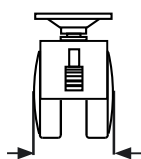

mm



static
kg

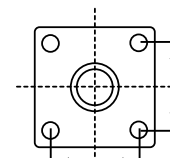

mm

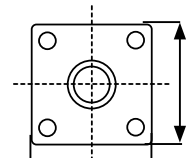

mm

08.04.028

40

56

41

25

32 x 32

42 x 42 x 2

08.04.096

50

64

47

30

32 x 32

42 x 42 x 2

TWIN WHEEL CASTOR W/KNOCK-IN SOCKET

TWIN WHEEL CASTOR W/KNOCK-IN SOCKET

Material: Wheel: Polyamid (PA), black.
Knock-in socket: Polyamid (PA), black.

Application: Knock-in socket $\varnothing 12 \times 12$ mm
(Not premounted).

With or without brake.



No brake



mm

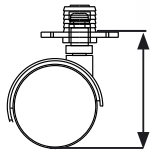

mm

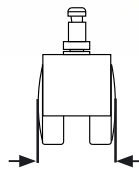

mm



static
kg



mm

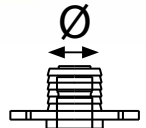

mm

08.04.001

30

43

32

15

12

12

08.04.016

40

56

38

25

12

12

08.04.087

50

64

47

30

12

12



With brake



mm

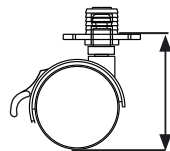

mm

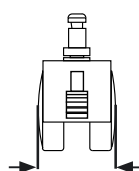

mm



static
kg



mm

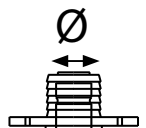

mm

08.04.014

40

56

41

25

12

12

08.04.086

50

64

47

30

12

12

TWIN WHEEL CASTOR W/THREADED STEM

- high quality furniture fittings



TWIN WHEEL CASTOR W/THREADED STEM

Material: Wheel: Polyamid (PA), black.
 Threaded stem: Steel, bright zinc plated.

Application: Premounted threaded stem in M8 & M10.
 With or without brake.



No brake



mm

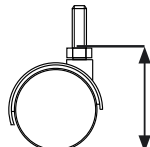

mm

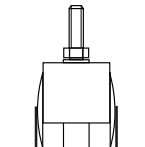

mm



static
kg

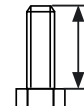

mm

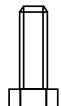

M

08.04.031

40

49

37

25

15

8

08.04.105

50

60

45

30

15

8

08.04.116

50

60

45

30

15

10

08.04.119

50

60

45

30

20

10



With brake



mm

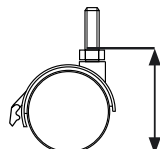

mm

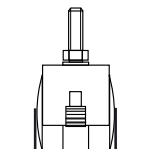

mm



static
kg



mm

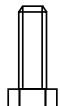

M

08.04.030

40

49

37

25

15

8

08.04.110

50

60

45

30

15

8

08.04.118

50

60

45

30

15

10

08.04.121

50

60

45

30

20

10

TWIN WHEEL CASTOR W/NYLON SOCKET

TWIN WHEEL CASTOR W/NYLON SOCKET



Material: Wheel: Polyamid (PA), black.
Socket: Polyamid (PA), black.

Application: Knock-in socket Ø10,5 x 30mm (not premounted).

Knock-in hole depth 33 mm

With or without brake.



No brake



mm

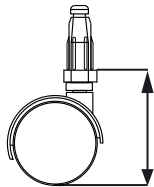

mm



mm



static
kg



mm

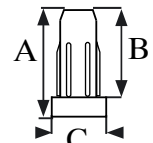

mm

08.04.015

40

53

38

25

10,5

A

B

C

33

30

15,5

08.04.017

50

65

47

30

10,5

33

30

15,5



With brake



mm

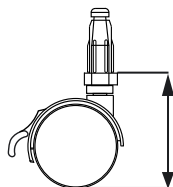

mm

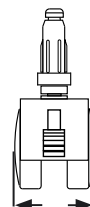

mm



static
kg



mm

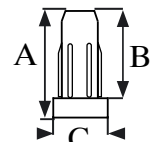

mm

08.04.013

40

53

38

25

10,5

A

B

C

33

30

15,5

08.04.018

50

65

47

30

10,5

33

30

15,5

TWIN WHEEL CASTOR W/U-BRACKET

- high quality furniture fittings



TWIN WHEEL CASTOR W/U-BRACKET

Material: Wheel: Polyamid (PA), black.
U-bracket : Steel, black zinc plated.

Application: Premounted U-bracket for 16 or 19 mm panel. With M 4 x 22 mm screw.

Without or without brake.



No brake



mm

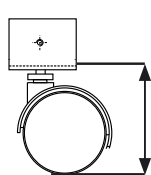

mm

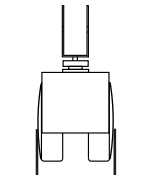

mm



static
kg



mm

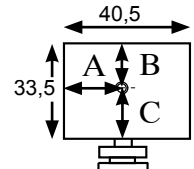

mm

08.04.032

40

56

41

25

16

A B C
20,25 7,5 26

08.04.036

40

56

41

25

19

20,25 7,5 26



With brake



mm

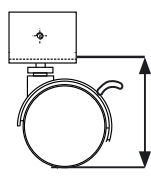

mm

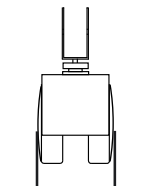

mm



static
kg



mm

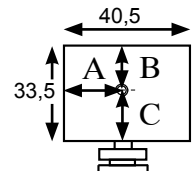

mm

08.04.033

40

56

41

25

16

A B C
20,25 7,5 26

08.04.037

40

56

41

25

19

20,25 7,5 26

**TWIN WHEEL CASTOR "LECCO"
W/PU TRACK - Ø 50 MM**

Material: Wheel hood & core: Polyamid (PA), black.
Wheel track: Polyurethane (PU), grey.
Top plate: 2 mm steel, bright zinc plated.

Application: Premounted top plate 42 x 42 mm.
Hole distance (c/c.) : 32 mm, Ø5 mm screw holes.
Recommended for hard surface.
Without brake.



mm

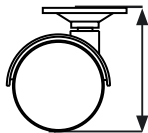

mm

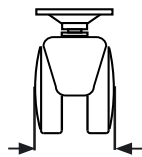

mm

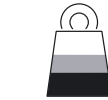

static/dynamic
kg

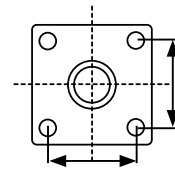

mm

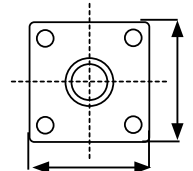

mm

08.04.099

50

65

45

50/30

32 x 32

42 x 42 x 2

**TWIN WHEEL CASTOR "BARI"
 W/PU TRACK - Ø 65 MM**

Material: Wheel hood & core: Polypropylene (PP), grey.
 Wheel track: Polyurethane (PU), black.
 Top plate: 2 mm steel, bright zinc plated.

Application: Premounted top plate 42 x 42 mm.
 Hole distance (c/c.) : 32 mm, Ø5 mm screw holes.
 Recommended for hard surface.
 With or without brake.

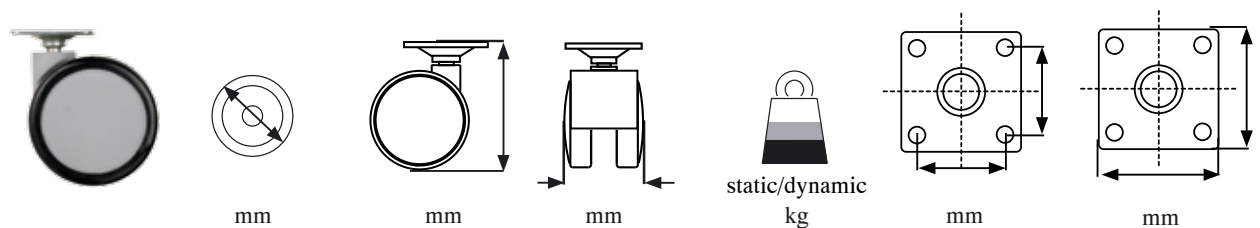

08.04.200 65 78 45 80/50 32 x 32 42 x 42 x 2

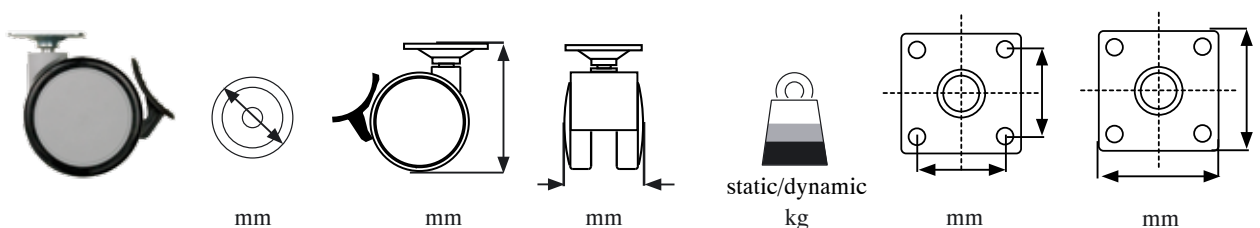

08.04.201 65 78 45 80/50 32 x 32 42 x 42 x 2



TEA TROLLEY CASTOR "FORCELLA"

TEA TROLLEY CASTOR "FORCELLA"

Material: Steel: Bronze (BRZ) or nickel Pl. (NPL).
 Wheel: Polyamid (PA), black.

Application: Metal socket $\varnothing 7 \times 35$ mm with black plastic bushing.

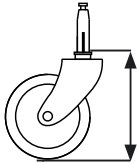
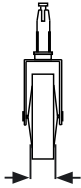

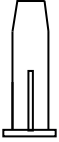
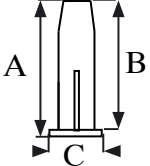
	FINISH					\varnothing 				
		mm	mm	mm	static kg	mm	A	B	C	
# 08.01.085	BRZ	38	46	8	9	10	30	17	28	
# 08.01.110	NPL	75	86	11	15	10	30	17	28	

FORK CASTOR W/TOP PLATE & TRANSPARENT PU WHEEL

- high quality furniture fittings



FORK CASTOR W/TOP PLATE & TRANSPARENT PU WHEEL

Material: Wheel track: Polyurethane (PU), transparent.
Wheel body: Polyurethane (PU), transparent.
Top plate: 1,8 mm steel, zinc plated.

Application: With premounted top plate 50 x 50 mm.
Recommended for hard surface.
With or without plastic brake.

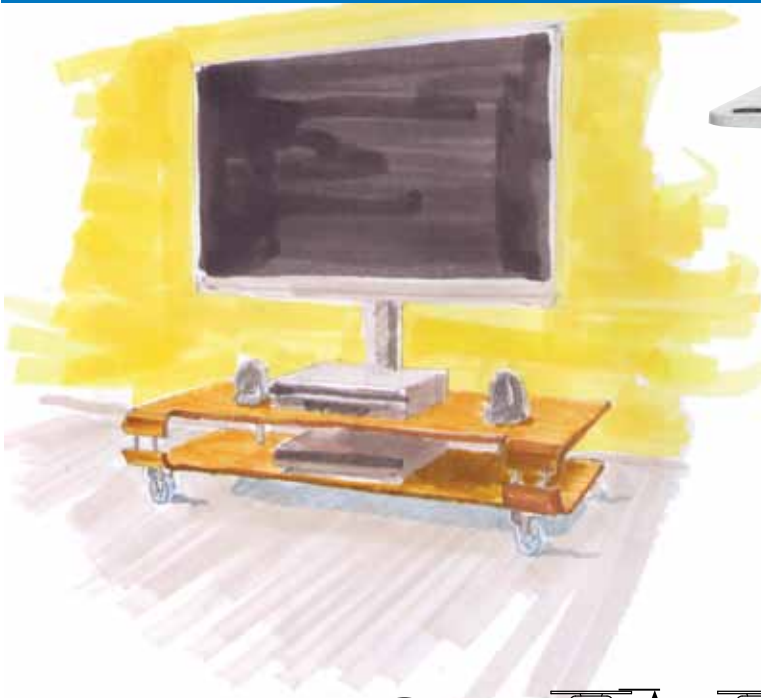

No brake



mm



mm

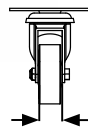

mm



static
kg

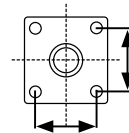

mm

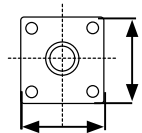

mm

08.12.290

35

51

20

25

38 x 38

50 x 50 x 1,8

08.12.300

50

65

20

50

38 x 38

50 x 50 x 1,8

08.12.310

75

90

23

70

38 x 38

50 x 50 x 1,8



With brake



mm

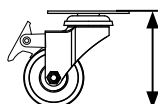

mm

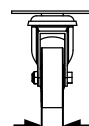

mm



static
kg

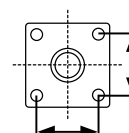

mm

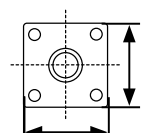

mm

08.12.291

35

51

20

25

38 x 38

50 x 50 x 1,8

08.12.301

50

65

20

50

38 x 38

50 x 50 x 1,8

08.12.311

75

90

23

70

38 x 38

50 x 50 x 1,8

FORK CASTOR W/TOP PLATE & COLORED TRANSPARENT PU WHEEL



Transparent Orange

Ø50 mm # 08.12.308
Ø75 mm # 08.12.318

Transparent Orange with brake

Ø50 mm # 08.12.309
Ø75 mm # 08.12.319



Transparent Black

Ø35 mm # 08.12.292
Ø50 mm # 08.12.302
Ø75 mm # 08.12.312

Transparent Black with brake

Ø35 mm # 08.12.293
Ø50 mm # 08.12.303
Ø75 mm # 08.12.313



Transparent Green

Ø50 mm # 08.12.306
Ø75 mm # 08.12.316

Transparent Green with brake

Ø50 mm # 08.12.307
Ø75 mm # 08.12.317



Transparent Blue

Ø50 mm # 08.12.304
Ø75 mm # 08.12.314

Transparent Blue with brake

Ø50 mm # 08.12.305
Ø75 mm # 08.12.315

BOX CASTOR - SCREW-ON W/ PP WHEEL

Material: Wheel: Polypropylene (PP), white or black.
 Mounting bracket: Steel, bright zinc plated.

Application: Mounting bracket: 19 x 42 mm.
 Hole distance (c/c): 32 mm.



Colour of wheel



mm

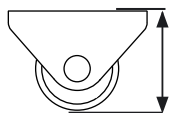

mm

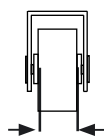

mm



static
kg

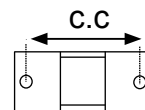

mm

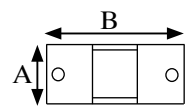

mm

							A B
# 08.06.010	White	25	28	13	25	32	19/42
# 08.06.027	Black	25	28,6	13	25	32	19/42
# 08.06.020	White	29	30	13	25	32	19/42
# 08.06.025	White	29	32	13	25	32	19/42

BOX CASTOR - W/ PU TRACK

Material: Wheel track: Polyurethane (PU), grey.
 Wheel core: Polypropylene (PP), black (Blk).
 Mounting bracket: Steel, bright zinc plated.

Application: Mounting bracket: 19 x 42 mm or 20 x 58 mm.
 Hole distance (c/c): 32 mm or 46 mm.
 Recommended for hard surface.

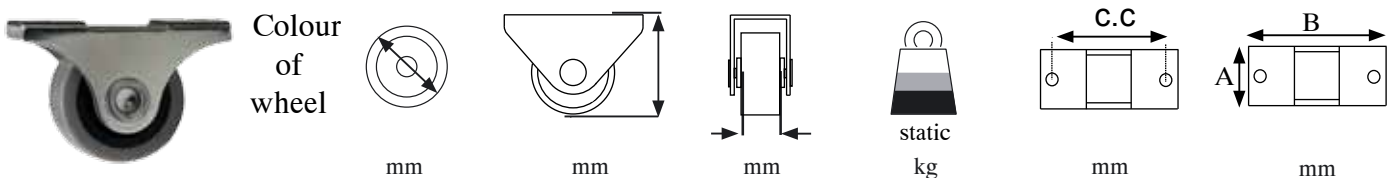

	Colour of wheel	mm	mm	mm	static kg	mm	mm
							A B
# 08.06.040	Grey/Blk	25	28	13	25	32	19/42
# 08.06.042	Grey/Blk	32	39	16	25	46	20/58
# 08.06.044	Grey/Blk	40	43	16	25	46	20/58

BOX CASTOR - INLAY TYPE

Material:	Wheel:	Polyamid (PA), black.
	Mounting ring:	Steel, bright zinc plated.
Mounting ring:		Ø26 x 1,5 mm.
Hole distance(c/c):		20 mm.
Application:		Inlay type, ideal for table legs.

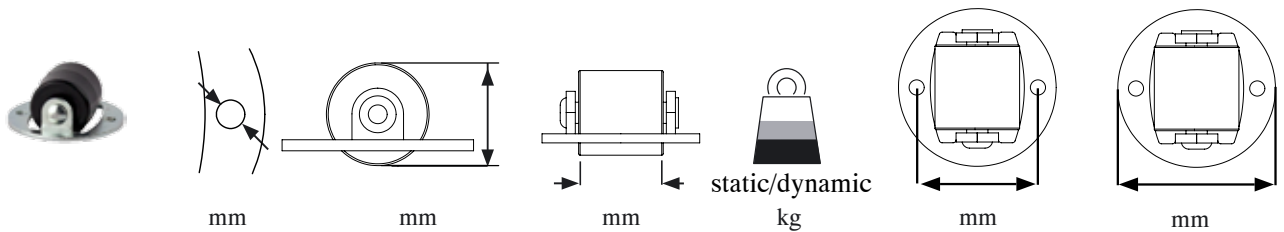
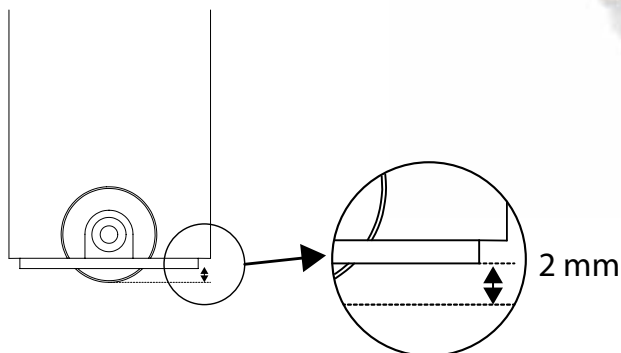

# 08.06.050	Ø2,5	Ø14 mm	14 mm	30/15	20 mm	Ø26 mm
-------------	------	--------	-------	-------	-------	--------

BRASS CASTOR "BRASCELLA"

BRASS CASTOR "BRASCELLA"

Material: Brass: Polished brass.

Application: Mounted by use of steel head F-593 12.09.890-0 & M8 hangerbolt. To be bought separately.

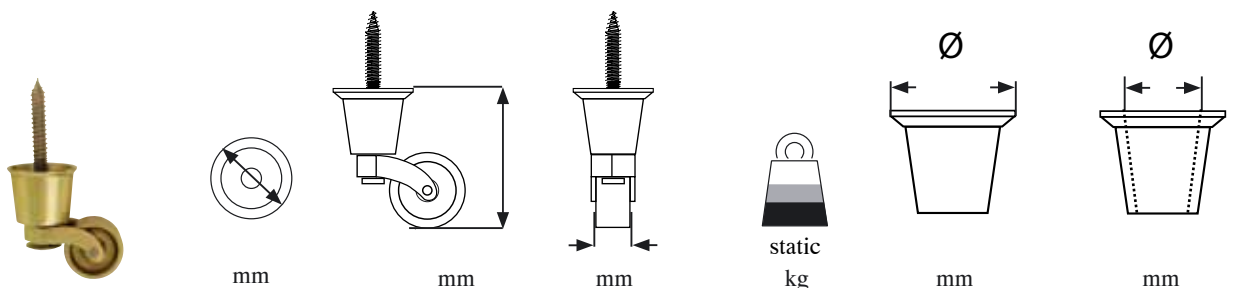
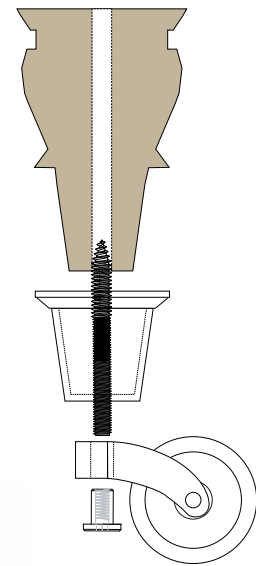

08.05.221

32

65

19

50

39

31,5

FORK CASTOR "GARDA" - Ø76 MM

- high quality furniture fittings



FORK CASTOR "GARDA" - Ø76 MM



Material: Wheel: Polypropylene (PP), grey.
Metal parts: Steel, bright zinc pl.

Application: Premounted top plate 42 x 42 mm.
Hole distance (c/c.) : 32 mm,
Ø5 mm screw holes.
With or without brake.



No brake



mm



mm

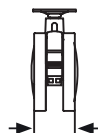

mm



static/dynamic
kg

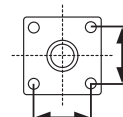

mm

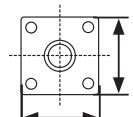

mm



With brake



mm

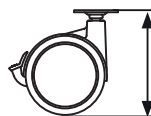

mm



mm



static/dynamic
kg

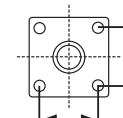

mm

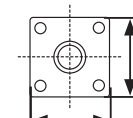

mm

08.12.400

76

100

47

50/25

32 x 32

42 x 42 x 1,5

08.12.405

76

100

47

50/25

32 x 32

42 x 42 x 1,5

FORK CASTOR W/TOP PL. & PU TRACK

STEEL FORK CASTOR W/TOP PLATE & PU TRACK



Material: Wheel track: Polyurethane (PU), grey.
Wheel core: Polypropylene (PP), black.
Metal parts: Steel, bright zinc pl.

Application: Premounted top plate.
Recommended for hard surface.
With or without brake.



Fork castor without brake



Fork castor with brake

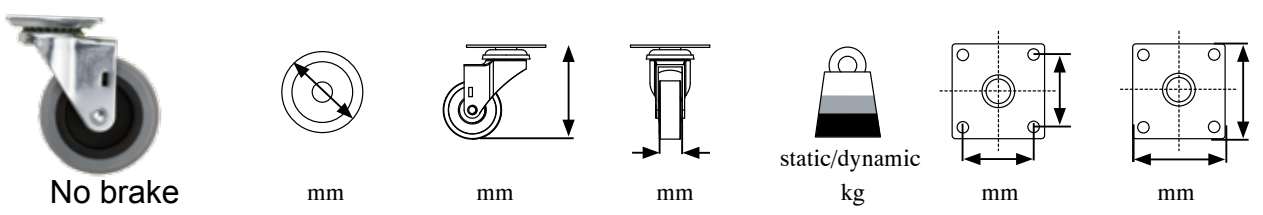

No brake	mm	mm	mm	static/dynamic kg	mm	mm
# 08.12.230	Ø50	65	18	60/35	32 x 32	42 x 42 x 2,5
# 08.12.232	Ø75	97	23	100/60	45,5 x 45,5	60 x 60 x 2,5

With brake	mm	mm	mm	static/dynamic kg	mm	mm
# 08.12.231	Ø50	65	18	60/35	32 x 32	42 x 42 x 2,5
# 08.12.233	Ø75	97	23	100/60	45,5 x 45,5	60 x 60 x 2,5

STEEL FORK CASTOR W/TOP PLATE & RUBBER TRACK



Material: Wheel: Grey soft rubber.
Metal parts: Steel, bright zinc pl.

Application: Premounted top plate.
Recommended for hard surface.
With or without brake.



Fork castor without brake



Fork castor with brake



No brake



mm

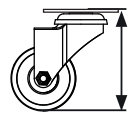

mm

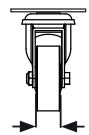

mm



static/dynamic
kg

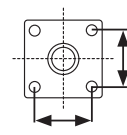

mm

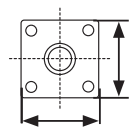

mm



With brake



mm

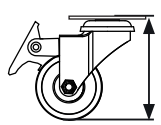

mm

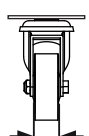

mm



static/dynamic
kg

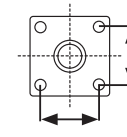

mm

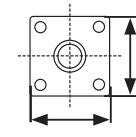

mm

# 08.12.161	50	72	16	45/30	35 x 35	50 x 50 x 1,5
# 08.12.163	75	104	21	60/45	45 x 45	65 x 65 x 2

# 08.12.162	50	72	16	45/30	35 x 35	50 x 50 x 1,5
# 08.12.164	75	104	21	60/45	45 x 45	65 x 65 x 2

FORK CASTOR W/TOP PL. & FULL BRAKE & RUBBER TRACK

STEEL FORK CASTOR W/TOP PLATE & FULL BRAKE & RUBBER TRACK

Material: Wheel: Grey soft rubber.
Metal parts: Steel, bright zinc plated.

Application: Premounted top plate.
Recommended for hard surface.
With total brake which prevents as well swivelling as turning.



Fork castor with full brake



With brake



mm

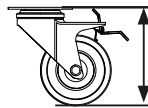

mm

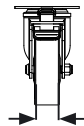

mm



static/dynamic
kg

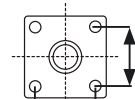

mm

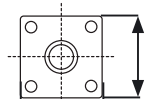

mm

08.12.167

75

104

21

60/45

45 x 45

65 x 65 x 2

Brake system in action

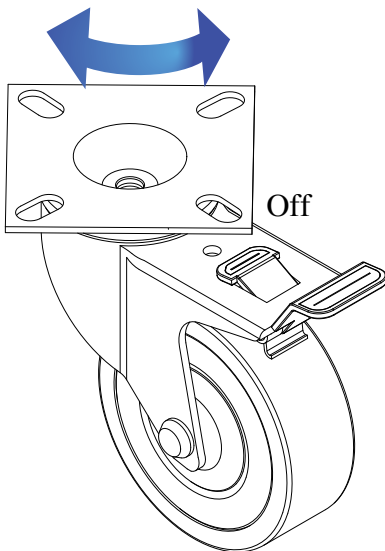

Off

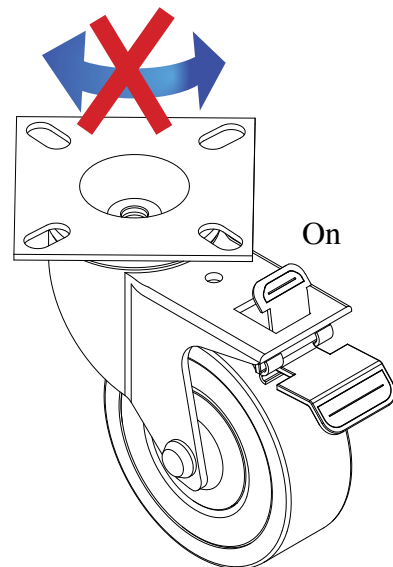
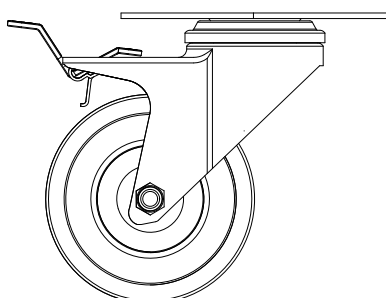

On

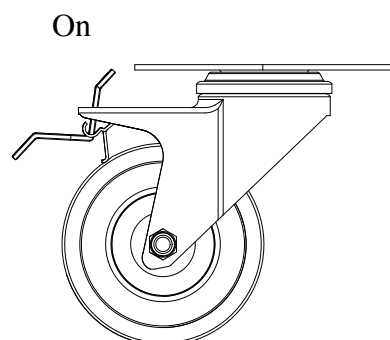

On

STEEL FORK CASTOR W/THREADED STEM & RUBBER TRACK



Material: Wheel: Grey soft rubber.
Metal parts: Steel, bright zinc plated.

Application: Premounted threaded stem in M10 x 30 mm.
Recommended for hard surface.
With or without brake.



Fork castor without brake



Fork castor with brake



No brake



mm

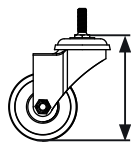

mm

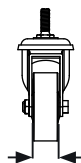

mm



static/dynamic
kg



M

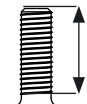

mm

08.12.165

75

102

21

60/45

M10

30



With brake



mm

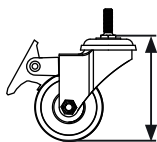

mm

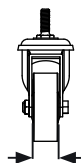

mm



static/dynamic
kg



M

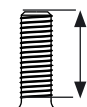

mm

08.12.166

75

102

21

60/45

M10

30

FORK CASTOR W/HOLE FOR BOLT & RUBBER TRACK

STEEL FORK CASTOR W/HOLE FOR BOLT & RUBBER TRACK

Material: Wheel: Grey soft rubber.
Metal parts: Steel, bright zinc plated.

Application: Hole for bolt.
Recommended for hard surface.
With or without brake.



Fork castor without brake



Fork castor with brake



No brake



mm

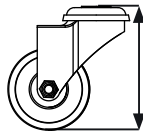

mm

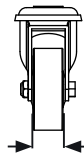

mm

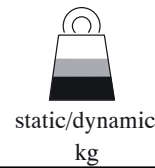

static/dynamic
kg

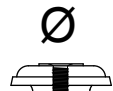

mm

# 08.12.168	50	70	16	45/30	10,5
# 08.12.170	75	102	21	60/45	10,5
# 08.12.205	100	132	25	70/55	12,5



With brake



mm

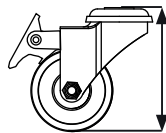

mm

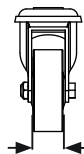

mm

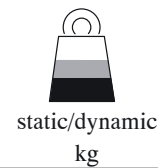

static/dynamic
kg

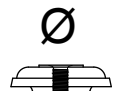

mm

# 08.12.169	50	70	16	45/30	10,5
# 08.12.171	75	102	21	60/45	10,5
# 08.12.206	100	132	25	70/55	12,5

STEEL FORK CASTOR W/FIXED PLATE & RUBBER TRACK

Material: Wheel: Grey soft rubber.
Metal parts: 1,5 mm steel, bright zinc plated.

Application: Premounted fixed top plate.
Recommended for hard surface.
Without brake.

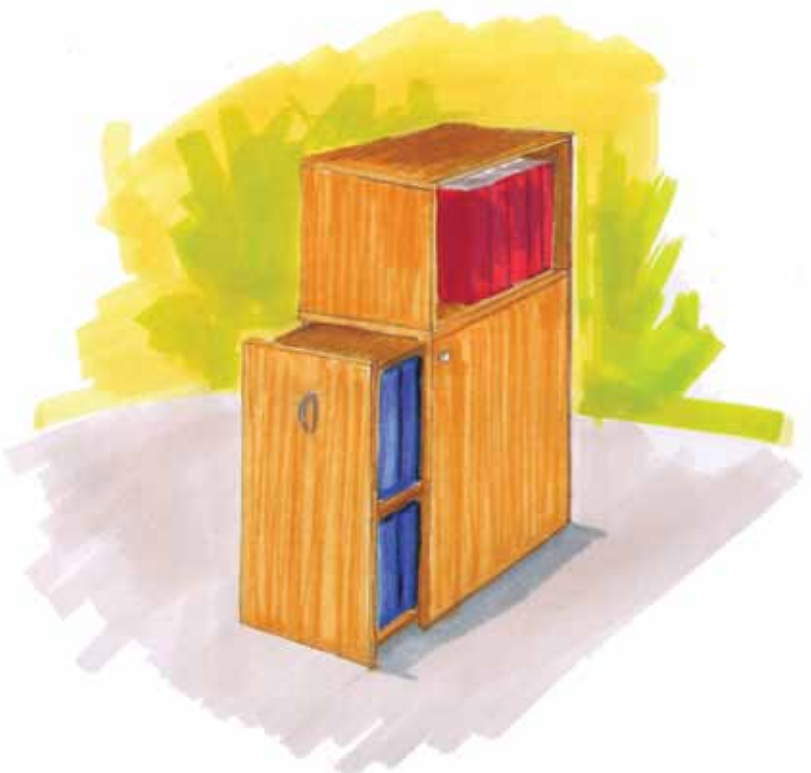

mm

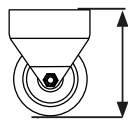

mm

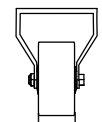

mm



static/dynamic
kg

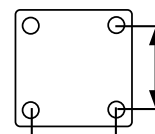

mm

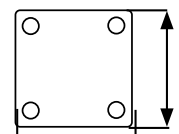

mm

08.12.150

50

67

20

45/30

30 x 30

45 x 45 x 1,5

INDUSTRIAL FORK CASTOR W/SWIVEL TOP PL. & RUBBER TRACK

INDUSTRIAL FORK CASTOR W/SWIVEL TOP PLATE & RUBBER TRACK

Material: Wheel: Grey rubber.
Metal parts: 4 mm steel, bright zinc plated.

Application: Premounted top plate.
With or without total brake which prevents as well swivelling as turning.
Recommended for hard surface.
With or without brake.



No brake



mm

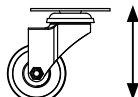

mm

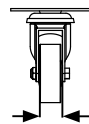

mm



static
kg

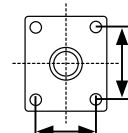

mm

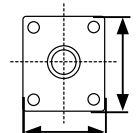

mm



With brake



mm



mm

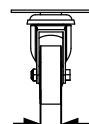

mm



static
kg

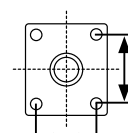

mm

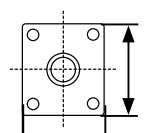

mm

# 08.12.210	160	170	40	150	80 x 105	110 x 135 x 4
# 08.12.215	200	218	40	230	80 x 105	110 x 135 x 4

# 08.12.211	160	170	40	150	80 x 105	110 x 135 x 4
# 08.12.216	200	218	40	230	80 x 105	110 x 135 x 4

Good advice in order to obtain optimum and correct use of your castors:

Diameter & hardness:

Castors with large diameter roll easily and absorb possible shocks.

Castors with wide treads (tracks) spread the load and provide good floor protection.

Castors with hard tread (track) offer higher load capacity and roll easily.

Castors with soft tread (track) provide a cushioned ride and a quiet operation.

What to use where?

Castors with hard tread (track) are ideal for industrial locations with rough floors and steel grates.

Castors with soft tread (track) protect the floor and offer a quiet operation – though, less suited for use on carpets.

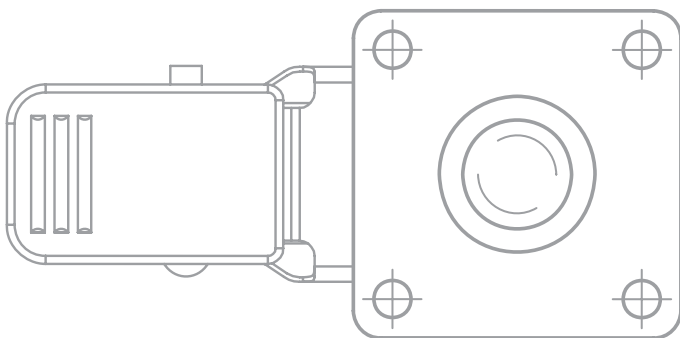
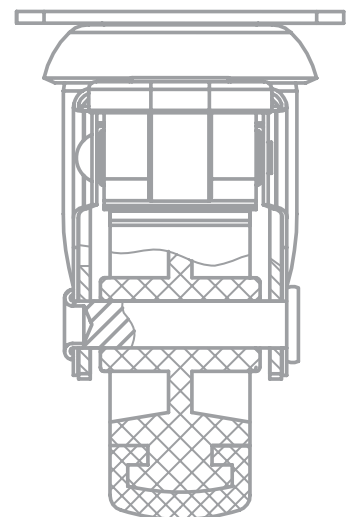
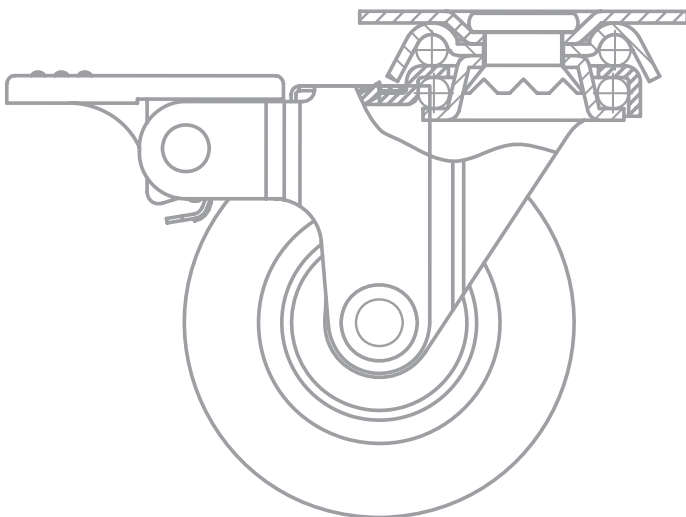

ALU LEGS "JACO" & "NIKO" W/TOP PLATE

ALU LEG "JACO" W/TOP PLATE



Material: Aluminium, silver sprayed or polished.
Tube: Aluminium, silver sprayed or polished.
Plug & spacer: Plastic, black.
Top plate: 2 mm steel, bright zinc plated.

Application: With premounted top plate 39 x 39 and 42 x 42 mm.



mm

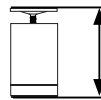

mm

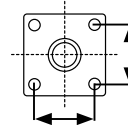

mm

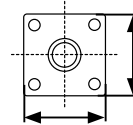

mm

Silver sprayed

Polished

# 06.09.465		40	58	29 x 29	39 x 39 x 2
# 06.09.466		40	100	29 x 29	39 x 39 x 2
# 06.09.467		40	150	29 x 29	39 x 39 x 2
# 06.09.475	# 06.09.495	60	58	32 x 32	42 x 42 x 2
# 06.09.476	# 06.09.496	60	100	32 x 32	42 x 42 x 2
# 06.09.477	# 06.09.497	60	150	32 x 32	42 x 42 x 2

ALU LEG "NIKO" W/TOP PLATE



Material: Aluminium, silver sprayed or polished.
Tube: Aluminium, silver sprayed or polished.
Plug & spacer: Plastic, black.
Top plate: 2 mm steel, bright zinc pl.

Application: With premounted top plate 39 x 39 and 42 x 42 mm.



mm

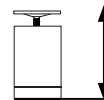

mm

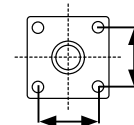

mm

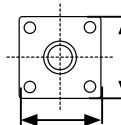

mm

Silver sprayed

Polished

# 06.09.455		40 x 40	58	29 x 29	39 x 39 x 2
# 06.09.456		40 x 40	100	29 x 29	39 x 39 x 2
# 06.09.457		40 x 40	150	29 x 29	39 x 39 x 2
# 06.09.471	# 06.09.492	60 x 60	58	32 x 32	42 x 42 x 2
# 06.09.472	# 06.09.493	60 x 60	100	32 x 32	42 x 42 x 2
# 06.09.473	# 06.09.494	60 x 60	150	32 x 32	42 x 42 x 2

ALU LEGS "TRIA" & "DOLLY" W/TOP PLATE

- high quality furniture fittings



ALU LEG "TRIA" W/TOP PLATE

Material: Tube: Aluminium, silver sprayed.
 Plug & spacer: Plastic, black.
 Top plate: 2 mm steel, bright zinc plated.

Application: With premounted top plate 39 x 39 mm.

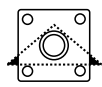

mm

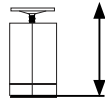

mm

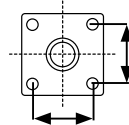

mm

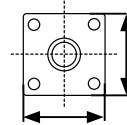

mm

# 06.09.468	40 x 40 x 55	58	29 x 29	39 x 39 x 2
# 06.09.469	40 x 40 x 55	100	29 x 29	39 x 39 x 2
# 06.09.470	40 x 40 x 55	150	29 x 29	39 x 39 x 2

ALU LEG "DOLLY" W/ADJUSTABLE TOP PLATE

Material: Leg: Aluminium anodized.
 Top plate & glide: Grey plastic.

Application: With round adjustable top plate Ø59 mm.
 Adjustable 30 mm.



FINISH

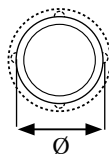

Ø

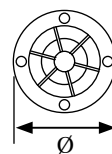

Ø

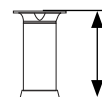

mm

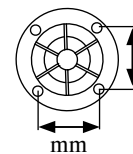

mm

# 06.09.500	Anodized	40	59	100 to 130	34 x 34
-------------	----------	----	----	------------	---------

ZAMAK LEG "DANUTA" W/ADJUSTABLE GLIDE

ZAMAK LEG "DANUTA" W/ADJUSTABLE GLIDE

Material: Tube: Zamak, chrome plated (CPL), mat nickel plated (NPL) or alu-sprayed (ALU).

Glide: Zamak cover & black plastic base.

Application: With fixed top plate 40 x 40.
Adjustable glide 10 mm.



FINISH

mm

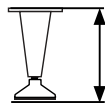

mm

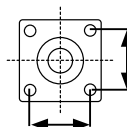

mm

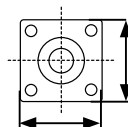

mm

# 06.09.365	Mat NPL	50 to 60	32 x 32	40 x 40 x 2
# 06.09.366	CPL	50 to 60	32 x 32	40 x 40 x 2
# 06.09.367	ALU	50 to 60	32 x 32	40 x 40 x 2
# 06.09.370	Mat NPL	80 to 90	32 x 32	40 x 40 x 2
# 06.09.371	CPL	80 to 90	32 x 32	40 x 40 x 2
# 06.09.372	ALU	80 to 90	32 x 32	40 x 40 x 2
# 06.09.375	Mat NPL	100 to 110	32 x 32	40 x 40 x 2
# 06.09.376	CPL	100 to 110	32 x 32	40 x 40 x 2
# 06.09.377	ALU	100 to 110	32 x 32	40 x 40 x 2

STEEL LEGS "ADRIA" W/THREADED STEM & "JIM" W/TOP PLATE

- high quality furniture fittings



STEEL LEG "ADRIA" W/THREADED STEM

Material: Leg: Steel, silver sprayed.
Base: Plastic, black.

Application: With threaded stem M8 x 25 mm.



FINISH

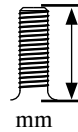
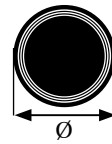
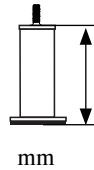
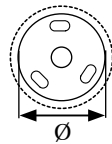

06.09.440

Silver

35

130

55

M8

25

STEEL LEG "JIM" W/TOP PLATE

Material: Leg: Steel, chrome plated (CPL).
Base: Plastic, black.

Application: With fixed top plate 58 x 77 mm.



FINISH

mm

Ø Tube

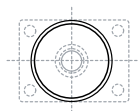

mm

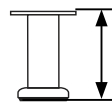

mm

Ø Base

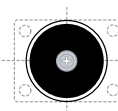

mm

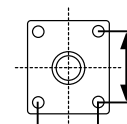

mm

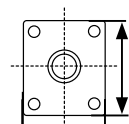

mm

06.12.027

CPL

50

50

87

44 x 63

58 x 77 x 1,5

06.12.025

CPL

50

150

73

44 x 63

58 x 77 x 1,5

STEEL LEGS "SOFI" & "PETER" W/ADJUSTABLE GLIDE

Peter *



Sofi *



STEEL LEGS "SOFI" & "PETER" W/ADJUSTABLE GLIDE

Material: Leg: Steel, chrome plated (CPL).
Steel, mat nickel plated (NPL).

Glide: CPL steel cover & black plastic base.

Application: With adjustable glide. 5 mm adjustment.

MODEL

FINISH

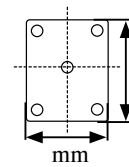
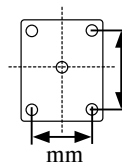
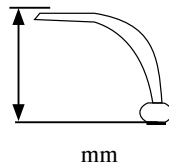

# 06.12.015	"SOFI"	CPL	110 to 115	30 x 51	53 x 87 x 2
# 06.12.010	"PETER"	CPL	115 to 120	30 x 51	53 x 87 x 2
# 06.12.011	"PETER"	Mat NPL	115 to 120	30 x 51	53 x 87 x 2

STEEL LEG "ANDY" W/ADJUSTABLE GLIDE



Material: Leg: Steel, chrome plated (CPL).
Base: Plastic, black.

Application: With fixed top plate 61 x 61 mm.
10 mm adjustment.

FINISH

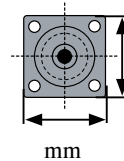
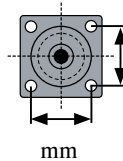
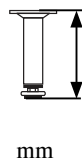
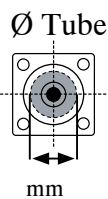

# 06.09.460	CPL	30	100 to 110	46 x 46	60 x 60 x 1,5
-------------	-----	----	------------	---------	---------------

TABLE METAL LEGS W/HEIGHT ADJUSTER

- high quality furniture fittings

TABLE METAL LEGS Ø 60 X 710 MM W/HEIGHT ADJUSTER

Material:	Tube:	0,8 mm steel.
	Mounting plate:	Aluminium diecast.
	Adjustment foot:	Black plastic.
Size:		Ø 60 x 710 mm.
Height adjustment:		0-25 mm.
Black painted		# 06.10.020
Chrome plated		# 06.10.022
Silver RAL 9006		# 06.10.023
SS-look (brushed nickel)		# 06.10.024
Packing:		1 set = 4 legs per box.
Other colors and sizes on request.		



ADJUSTABLE GLIDE “ALPHA”

Material: Base: Polyamid (PA), black.
Stud: Steel, bright zinc plated.

Application: W/Knurlled edge on base.



Item - number	Finish	D diameter	H height	M size	S stud
10.16.006	Black	Ø15	6 mm	M6	22 mm
10.16.011	Black	Ø20	6 mm	M6	22 mm
10.16.016	Black	Ø20	6 mm	M6	40 mm
10.16.025	Black	Ø25	6 mm	M6	22 mm
10.16.027	Black	Ø25	6 mm	M8	22 mm
10.16.035	Black	Ø32	8 mm	M8	22 mm
10.16.040	Black	Ø38	9 mm	M8	26 mm
10.16.046	Black	Ø44	10 mm	M8	26 mm
10.16.120	Black	Ø60	10 mm	M10	34 mm

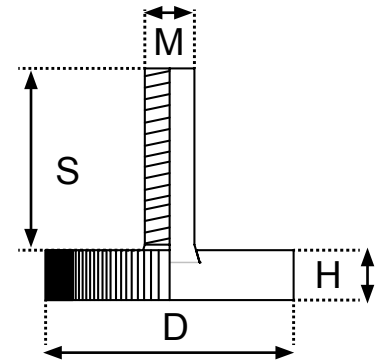

ADJUSTABLE GLIDE “MAU”

Material: Base: Polypropylene (PP), black.
Shell: Steel, zinc plated.
Stud: Steel, bright zinc plated.

Application: W/Knurlled edge on base.



Item - number	Finish	D diameter	H height	M size	S stud
#10.16.210	Black/ZP	Ø20	7 mm	M6	20 mm
#10.16.214	Black/ZP	Ø28	8 mm	M8	22 mm
#10.16.215	Black/ZP	Ø28	8 mm	M8	38 mm
#10.16.230	Black/ZP	Ø32	9 mm	M10	25 mm

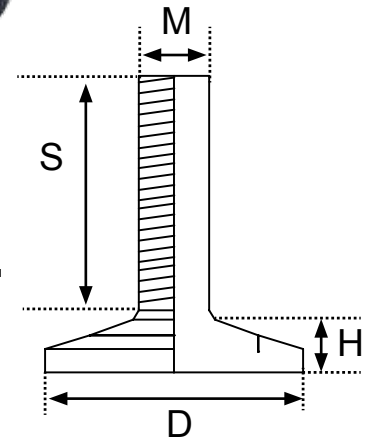

ADJUSTABLE GLIDE “VELA”

Material: Base: Polyamid (PA), black.
Stud: Steel, bright zinc plated.

Application: W/Knurled edge on base.

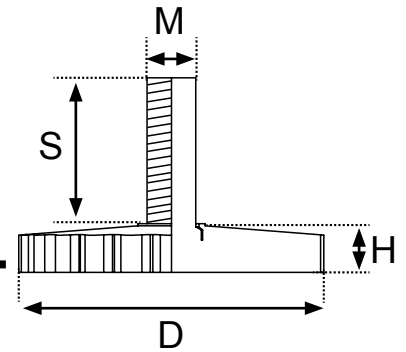

Item - number	Finish	D diameter	H height	M size	S stud
# 10.15.220	Black	Ø40	8 mm	M8	40 mm
# 10.15.250	Black	Ø50	8 mm	M8	40 mm
# 10.15.260	Black	Ø50	8 mm	M10	22 mm

ADJUSTABLE GLIDE “OCTO”

Material: Base: Polyamid (PA), black.
Stud: Steel, bright zinc plated.

Application: W/ Square hole 6x6 mm in bottom of base & 4 mm hex hole in top of the stud for quick fixing.

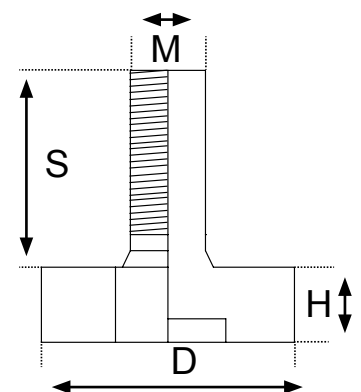

Item - number	Finish	D diameter	H height	M size	S stud
# 10.17.135	PA	27	8 mm	M8	21 mm
# 10.17.140	PA	27	9 mm	M10	35 mm

ADJUSTABLE GLIDE "BETA"

Material: Base: Polyamid (PA), black.
Stud: Steel, bright zinc plated.

Application: W/Slot in bottom of base for quick fixing.



Item - number	Finish	D diameter	H height	M size	S stud
#10.17.047	Black	Ø20	7 mm	M6	6 mm
#10.17.053	Black	Ø20	7 mm	M6	22 mm

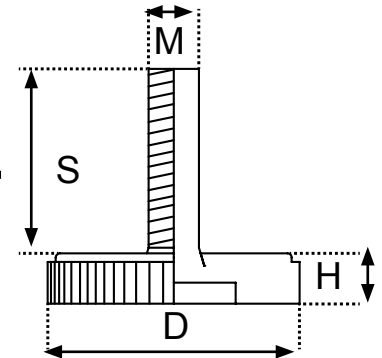

ADJUSTABLE GLIDE "SOLO"

Material: Base: Polyamid (PA), black.
Stud: Steel, bright zinc plated.

Application: W/Knurled edge & pozidriv in bottom of base for quick fixing.



Item - number	Finish	D diameter	H height	M size	S stud
# 10.17.070	Black	Ø29	10 mm	M6	18 mm
# 10.17.071	Black	Ø29	10 mm	M8	18 mm

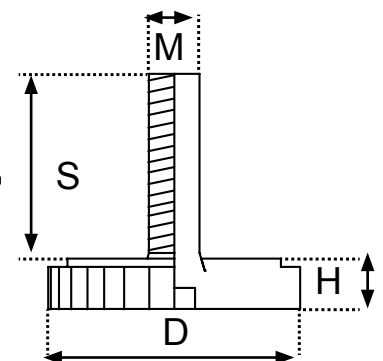

ADJUSTABLE GLIDES

- high quality furniture fittings

SISO DENMARK

ADJUSTABLE GLIDE “ARC”

Material: Base: Polyamid (PA), black.
Cover shell: Steel, chrome plated.
Stud: Steel, bright zinc plated.

Application: W/Pozidriv in bottom of base for quick fixing.



10.12.410



10.12.412

Item - number	Finish	D diameter	H height	M size	S stud
# 10.12.400	Black/CPL	Ø30	12,75 mm	M8	20 mm
# 10.12.410	Black/CPL	Ø40	12,75 mm	M8	20 mm
# 10.12.412	Black	Ø40	12,75 mm	M8	20 mm
# 10.12.420	Black	Ø50	12,75 mm	M8	20 mm

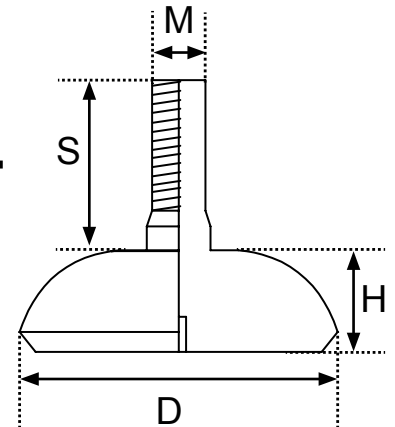

ADJUSTABLE GLIDE “JACK”

Material: Base: Polypropylene (PP), black.
Stud: Steel, bright zinc plated.

Application: W/Plastic hex nut for easy height adjustment & with pozidriv in bottom of base & in top of the stud for quick fixing.



Item - number	Finish	D diameter	H height	M size	S stud
# 10.15.050	Black	Ø25	15 mm	M8	25 mm
# 10.15.060	Black	Ø30	15 mm	M8	25 mm

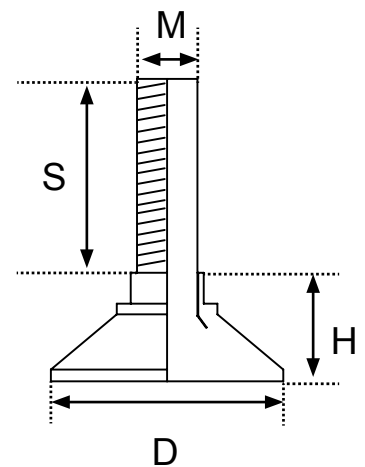

ADJUSTABLE GLIDE "TITAN"

Material: Base: Polypropylene (PP), white or black.
Shell: Steel, chrome or zinc plated.
Stud: Steel, bright zinc plated.

Application: W/Hex nut for easy height adjustment (10.12.077 without hex nut).

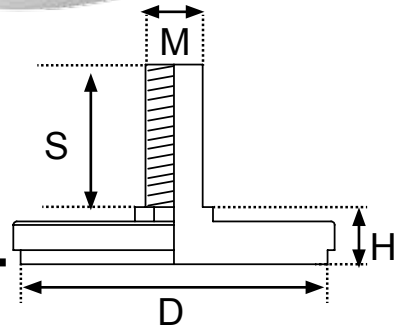

Item - number	Finish	D diameter	H height	M size	S stud
#10.12.076	White/CPL	Ø26	10 mm	M8	25 mm
#10.12.077	Black/ZPL	Ø27	11 mm	M8	18 mm
#10.12.095	White/CPL	Ø43	13 mm	M8	25 mm

ADJUSTABLE GLIDE "STRATO"

Material: Base: Polypropylene (PP), black.
Cover shell: Steel, chrome plated.
Stud: Steel, bright zinc plated.

Application: W/Hex nut for easy height adjustment.
Swivel stud for smooth leveling.

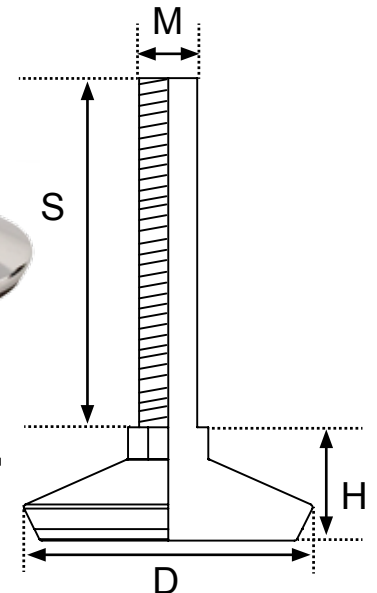

Item - number	Finish	D diameter	H height	M size	S stud
# 10.12.300	Black/CPL	Ø50	20	M10	60 mm

ADJUSTABLE GLIDE “TIME”

Material: Base: Polypropylene (PP), black.
Stud: Steel, bright zinc plated.

Application: W/Hex nut for easy height adjustment and M4 hex hole in top of the stud for quick fixing.
Swivel stud for smooth leveling.

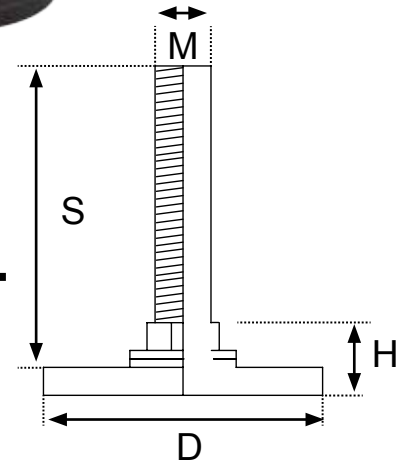

Item - number	Finish	D diameter	H height	M size	S stud
# 10.13.510	Black	Ø50	14 mm	M10	34 mm
# 10.13.520	Black	Ø50	14 mm	M10	98 mm

ADJUSTABLE GLIDE “NORFOLK”

Material: Base: Steel, nickel plated or SS-304.
Stud: Steel, bright zinc plated.
Cushion: Black rubber.

Application: W/Rubber silencer cushion for quiet working environment.

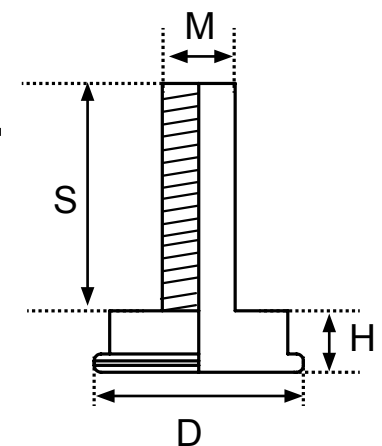

Item - number	Finish	D diameter	H height	M size	S stud
#10.21.290	Black/NPL	Ø23	10 mm	M8	25 mm
#10.21.321	Black/SS-304	Ø30	12 mm	M8	25 mm

ADJUSTABLE GLIDE “CONWAY”

Material: Base: Polypropylene (PP), black.
Stud: Steel, bright zinc plated.

Application: W/Hex nut for easy height adjustment.
Oscillating stud for angle adjustment.

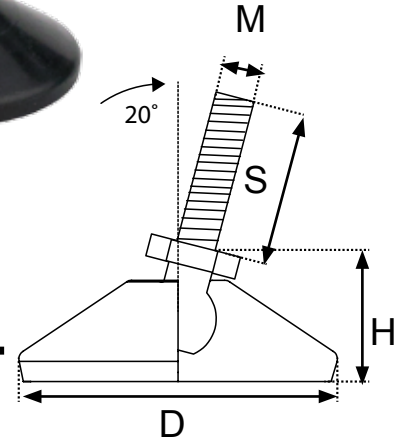

Item - number	Finish	D diameter	H height	M size	S stud
#10.08.026	Black	Ø26	21 mm	M8	25 mm
#10.08.131	Black	Ø30	21 mm	M8	25 mm
#10.08.161	Black	Ø44	21 mm	M10	34 mm
#10.08.171	Black	Ø50	21 mm	M8	25 mm

ADJUSTABLE GLIDE “COLORADO”

Material: Base: Polypropylene (PP), black.
Cover shell: Steel, chrome plated.
Stud: Steel, bright zinc plated.

Application: W/Hex nut for easy height adjustment.
Oscillating stud for angle adjustment.

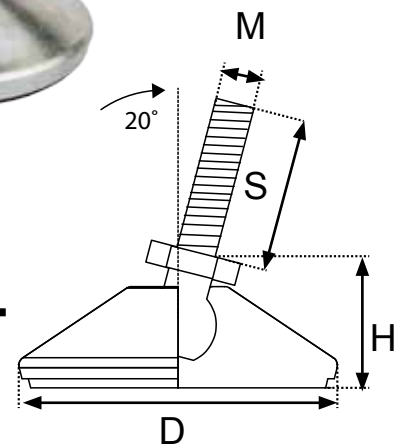

Item - number	Finish	D diameter	H height	M size	S stud
#10.08.230	Black/CPL	Ø50	22 mm	M8	25 mm
#10.08.241	Black/CPL	Ø50	22 mm	M10	34 mm

ADJUSTABLE GLIDE “COMO”

Material: Base: Steel, bright zinc plated.
Cover: Transparent polyethylene (PE).
Stud: Steel, bright zinc plated.

Application: W/Slot in top of stud for quick fixing.
Swivel stud for smooth leveling.

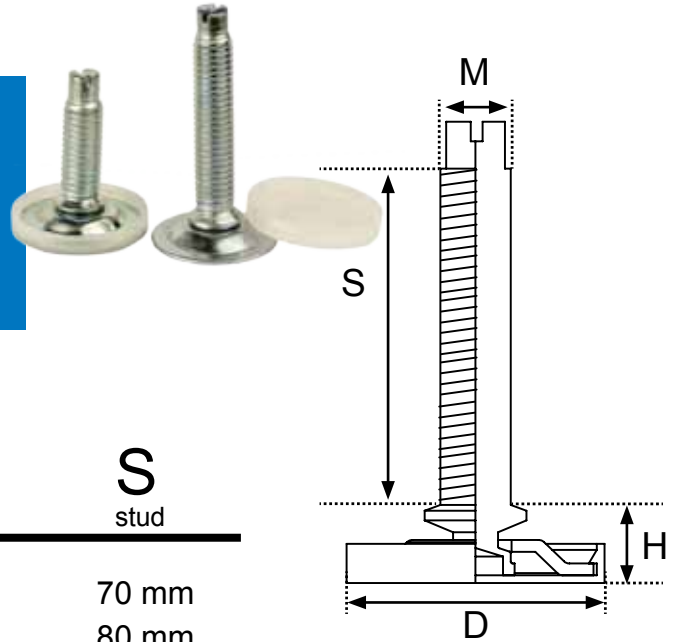

Item - number	Finish	D diameter	H height	M size	S stud
#10.16.250	BZP	Ø33	6 mm	M8	70 mm
#10.16.278	BZP	Ø33	6 mm	M10	80 mm
#10.16.279	BZP	Ø33	6 mm	M10	90 mm
#10.16.270	BZP	Ø33	6 mm	M10	100 mm

ADJUSTABLE GLIDE “MEGA”

Material: Base: Steel, bright zinc plated.
Stud: Steel, bright zinc plated.

Application: W/5mm hex hole in top of the stud for quick fixing.
Heavy duty type.
Swivel stud for smooth leveling.

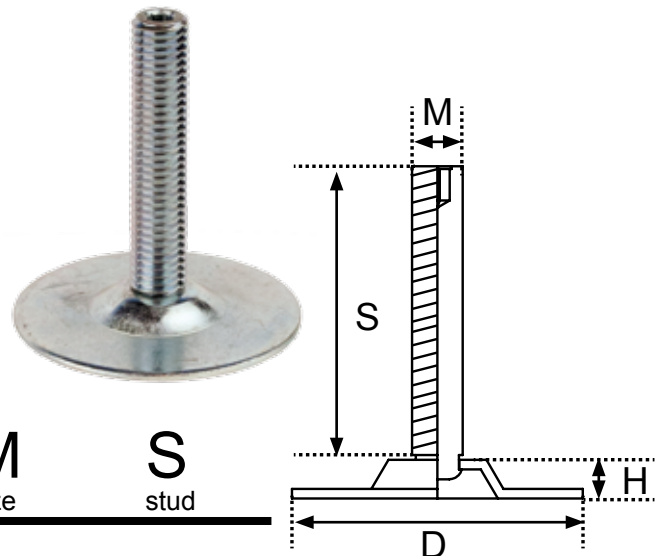

Item - number	Finish	D diameter	H height	M size	S stud
# 10.09.010	BZP	Ø60	7 mm	M12	60 mm

ADJUSTABLE GLIDES

JUMBO GLIDES W/TOP PLATE

Material: Body: Polyamid (PA), chrome plated (CPL).
Base: Polyamid (PA), black.

Application: With top plate 38 x 38 mm and 42 x 42 mm.



7055

6363



6747

5746

MODEL

FINISH

Ø Base



Ø



mm

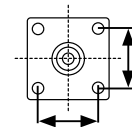

mm

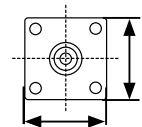

mm

# 09.01.063	# 5746	CPL	55	45	26 x 26	38 x 38 x 1,5
# 09.01.065	# 6747	CPL	68	46	26 x 26	38 x 38 x 1,5
# 09.01.066	# 6363	CPL	63	62	32 x 32	42 x 42 x 2
# 09.01.067	# 7055	CPL sparkled	70	54	32 x 32	42 x 42 x 2

CUP LEVELLER W/ADJUSTABLE GLIDE

Material: Polyamid (PA), black.

Application: Knock in mounting. Ø 10 mm bore.
Adjustable glide w/M4 hex hole.



Ø Cup

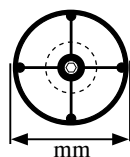

mm

Ø Glide

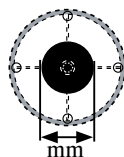

mm

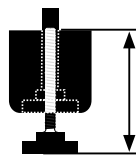

mm

Ø Bore x H

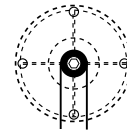

mm H= height

# 10.16.410	50	25	27 to 36	10 x 13
# 10.16.415	50	25	43 to 53	10 x 13

MORTISE LEVELLER



Material: Polyamid (PA), black.
Application: Knock in mounting. Ø 10 mm bore.
 Adjustable glide w/M8 hex hole.

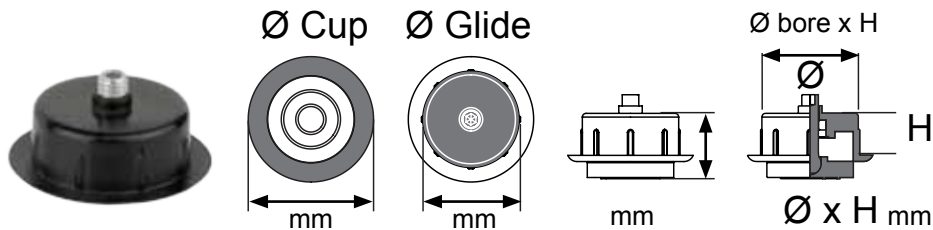

# 10.16.310	40	35	18 to 28	40 x 15
-------------	----	----	----------	---------

ADJUSTABLE CORNER BRACKET "ANGOLO"

Material: Glide: Steel, bright zinc plated.
 Bracket: Steel, bright zinc plated.
 Cover cap: Polyethylene (PE), white.

Application: W/4 mm hex hole in top of stud for quick fixing.
 Swivel stud for smooth leveling.
 W/Cover cap for floor protection.
 Left or right hand model.



Item - number	Site L or R	D glide	H height	M size	S stud
# 10.16.510	Left	Ø32,5 x 1	1 mm	M8	60 mm
# 10.16.511	Right	Ø32,5 x 1	1 mm	M8	60 mm

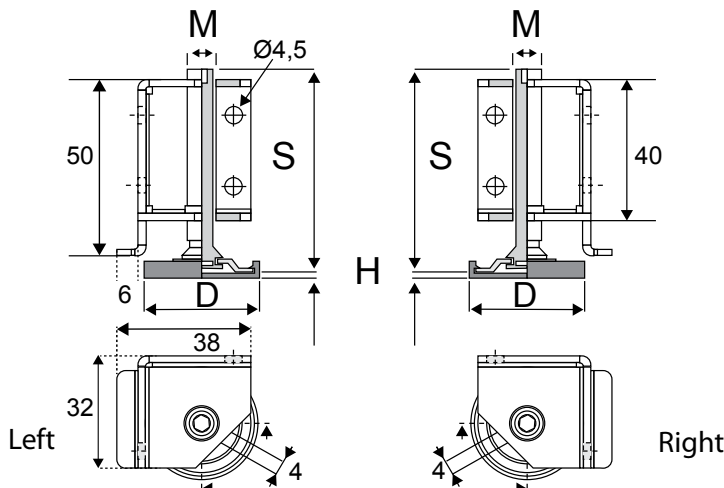

CONCEALED ADJUSTER

Material: Base: Polyamid (PA), black.
 Stud: Steel, bright zinc plated.
 Bracket: Zamak, natural.

Application: W/4mm hex hole in top of stud for quick fixing.
 Oscillating stud for angle adjustment.
 For panel thickness 18 - 30mm.
 W/fixing pin $\varnothing 5 \times 9$ mm.

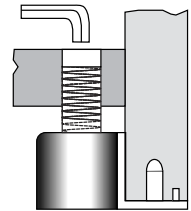

Item - number	G glide	T tread	S stud
#10.16.510	$\varnothing 20 \times 9$ mm	M8	32 mm

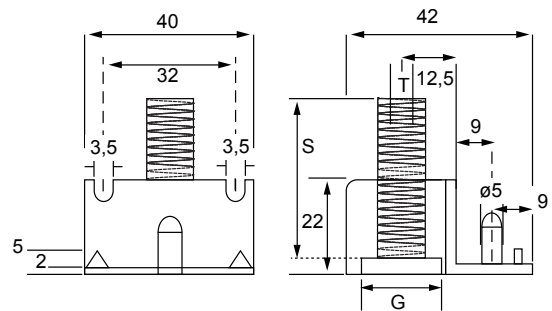

KNOCK-IN PANEL ADJUSTER

Material: Base & bracket: Polyamid (PA), black.
 Stud: Steel, bright zinc plated.

Application: W/Hex nut for easy height adjustment and slot in top of the stud for quick fixing.
 W/Knock-in pins $\varnothing 10 \times 10$ mm, c/c: 32 mm.



Item - number	G glide	T tread	S stud
#10.16.520	$\varnothing 23 \times 8$ mm	M8	60 mm

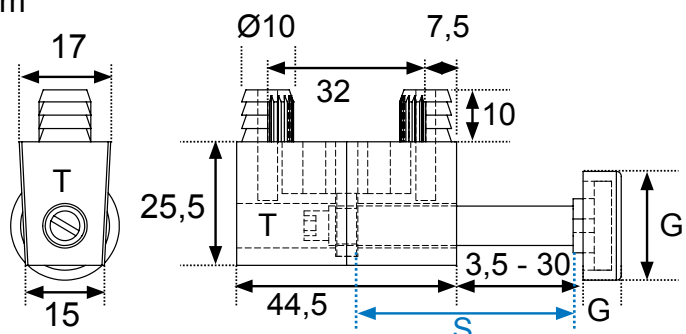

PLASTIC PANEL SHOE W/ADJUSTER

Material: Glide base: Polyamid (PA), black.
 Stud: Steel, bright zinc plated.
 Shoe body: Polyamid (PA), black.

Application: W/Knurled edge on base for smooth fixing.
 F/panel thickness 18, 25 & 28 mm.
 F/mounting on panel end only.



Item - number	Panel thickness	D glide	M size	S stud
#10.16.345	18 mm	Ø24 x 8 mm	M6	22 mm
#10.16.350	25 mm	Ø31 x 8 mm	M8	22 mm
#10.16.360	28 mm	Ø31 x 8 mm	M8	22 mm

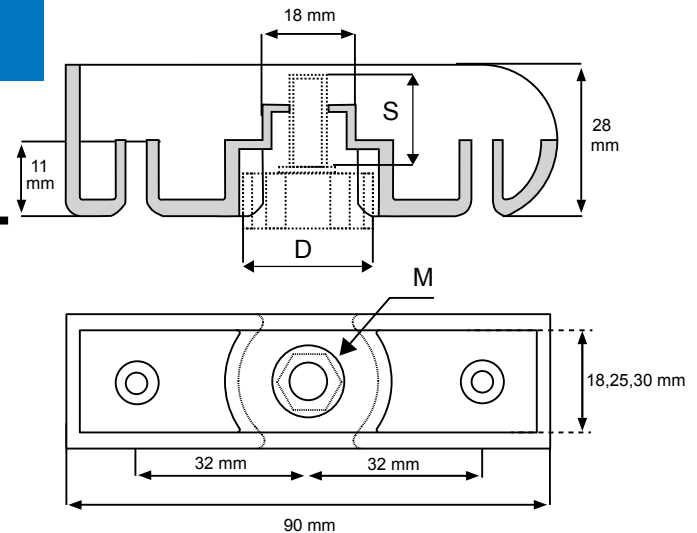

METAL PANEL SHOE "HALFMOON"

Material: Bracket: 2mm steel.
 Finish: Black or silver painted.

Application: F/panel thickness 18 mm.
 W/M6 hole for adjustable glide. Glide to be bought separately.

Adjustable Glide "Beta" item 10.17.053 is recommend.



Item - number	Color	W panel	L length	H height	S screw holes	D hole distance
#10.16.380	Silver	18 mm	58 mm	20 mm	2 x Ø4 mm	c/c: 32 mm
#10.16.381	Black	18 mm	58 mm	20 mm	2 x Ø4 mm	c/c: 32 mm

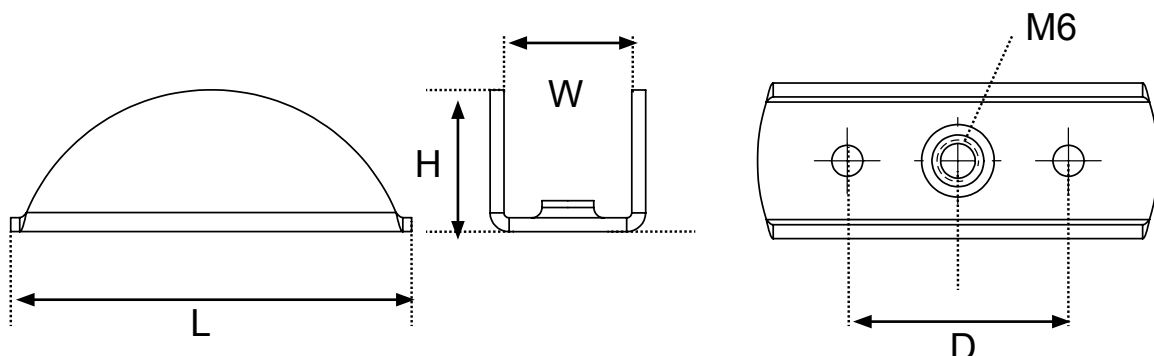

PLASTIC TACK, NAIL-ON GLIDE

Material: Base: Polyethylene, (PE), brown or white.
Nail: Steel, zinc plated.

Application: Nail-on glide with Ø2 x 15 mm nail.

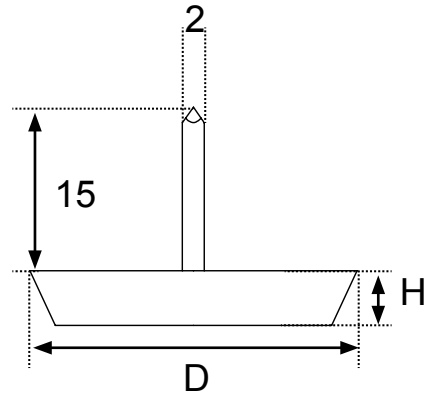
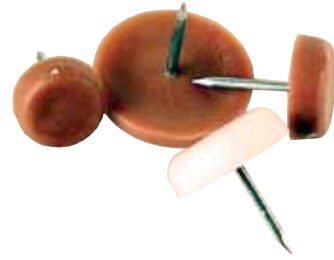

Item - number	Finish	D diameter	H height
#10.25.018	White	Ø13 mm	6 mm
#10.25.020	White	Ø15 mm	6 mm
#10.25.021	Brown	Ø15 mm	6 mm
#10.25.030	White	Ø18 mm	6 mm
#10.25.031	Brown	Ø18 mm	6 mm
#10.25.050	White	Ø22 mm	6 mm
#10.25.058	Brown	Ø28 mm	6 mm

PLASTIC TACK W/FELT, NAIL-ON GLIDE

Material: Base: Polyethylene, (PE), brown or white.
Nail: Steel, zinc plated.
Felt: Grey.

Application: Nail-on glide with Ø1,6 x 13 mm nail.

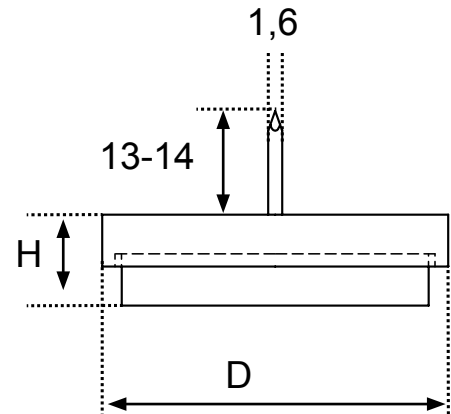

Item - number	Finish	D diameter	H height	Felt - thickness
# 10.25.078	White	Ø15	8 mm	4 mm
# 10.25.079	Brown	Ø15	8 mm	4 mm
# 10.25.082	White	Ø18	8 mm	4 mm
# 10.25.083	Brown	Ø18	8 mm	4 mm
# 10.25.086	White	Ø22	8 mm	4 mm
# 10.25.087	Brown	Ø22	8 mm	4 mm
# 10.25.090	White	Ø28	8 mm	4 mm
# 10.25.091	Brown	Ø28	8 mm	4 mm

PLASTIC TACK W/FELT, SCREW-ON GLIDE

Material: Base: Polystyrol, (PS), white.
Stud: Steel, zinc plated.
Felt: Grey.

Application: Screw-on glide with $\text{Ø}3,5 \times 20$ mm pozidriv screw.

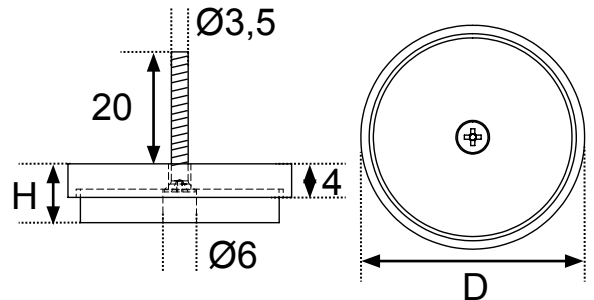

Item - number	Finish	D diameter	H height	Felt - thickness
# 10.25.100	White	Ø20	8 mm	4 mm
# 10.25.105	White	Ø24	8 mm	4 mm
# 10.25.110	White	Ø28	8 mm	4 mm
# 10.25.115	White	Ø40	8 mm	4 mm

STEEL TACK, NAIL-ON GLIDE

Material: Base: Steel, nickel plated.
Nail: Steel, zinc plated.

Application: Nail-on glide with nail.

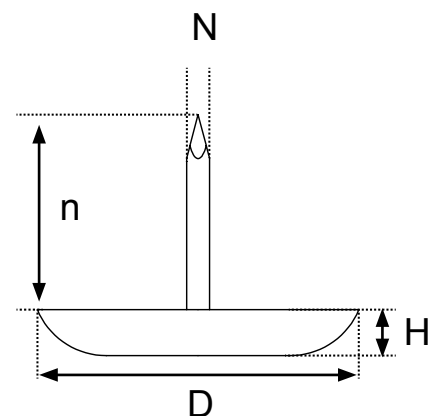

Item - number	Finish	D diameter	H height	N _{nail} diameter	n _{nail} length
# 10.22.020	NPL	Ø13	3 mm	Ø1,4 mm	12 mm
# 10.22.040	NPL	Ø15	3 mm	Ø1,4 mm	14 mm
# 10.22.050	NPL	Ø16	3,2 mm	Ø1,75 mm	14 mm
# 10.22.060	NPL	Ø18	4 mm	Ø1,75 mm	16 mm
# 10.22.070	NPL	Ø20	4 mm	Ø2 mm	18 mm
# 10.22.080	NPL	Ø23	4 mm	Ø2 mm	19 mm
# 10.22.090	NPL	Ø25	4 mm	Ø2 mm	19 mm
# 10.22.100	NPL	Ø28	5 mm	Ø2 mm	20 mm
# 10.22.110	NPL	Ø30	5 mm	Ø2 mm	20 mm
# 10.22.120	NPL	Ø35	5 mm	Ø2,5 mm	27 mm

NAIL-ON GLIDE "NORFOLK"

Material: Base: Steel, nickel plated.
 Nail: Steel, zinc plated.
 Cushion: Black rubber.

Application: W/Rubber silencer cushion for quiet working environment.
 Nail-on glide with flexible nail for angled chair legs.

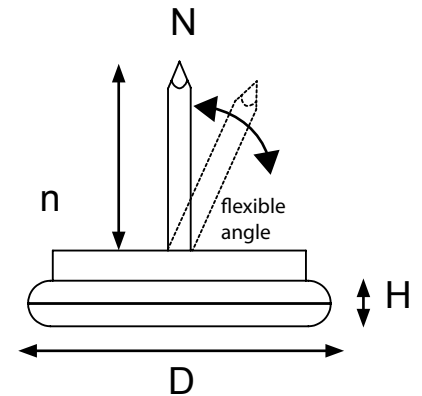

Item - number	Finish	D diameter	H height	N _{nail} diameter	n _{nail} length
# 10.21.010	NPL	Ø18	9 mm	2,4 mm	14 mm
# 10.21.020	NPL	Ø20	9 mm	2,4 mm	14 mm
# 10.21.030	NPL	Ø23	10 mm	2,4 mm	15 mm
# 10.21.040	NPL	Ø26	10mm	2,4 mm	15 mm
# 10.21.050	NPL	Ø30	10mm	2,4 mm	15 mm
# 10.21.060	NPL	Ø40	10mm	3 mm	26 mm

STEEL GLIDE, W/3 PRONGS - KNOCK-IN

Material: Base: Steel, nickel plated.

Application: Knock-in glide with 3 prongs.

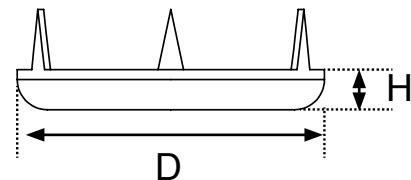

Item - number	Finish	D diameter	H height
# 10.23.010	NPL	Ø10	2,7 mm
# 10.23.020	NPL	Ø13	3,6 mm
# 10.23.030	NPL	Ø15	3,8 mm
# 10.23.040	NPL	Ø18	4,2 mm
# 10.23.050	NPL	Ø20	4,2 mm
# 10.23.060	NPL	Ø22	4,2 mm
# 10.23.070	NPL	Ø24	4,5 mm
# 10.23.080	NPL	Ø27	4,8 mm
# 10.23.090	NPL	Ø30	5,7 mm
# 10.23.100	NPL	Ø35	6,0 mm
# 10.23.110	NPL	Ø38	6,5 mm

TUBE RIVET PLASTIC GLIDE - KNOCK-IN

Material: Base: Polyethylene, (PE), white.
Rivet: Steel, zinc plated.

Application: Knock-in glide with Ø9 x 4 mm steel rivet.



Item - number	Finish	A diameter	B height	C height	D diameter
# 10.50.160	White/ZPL	Ø20	5,5 mm	4 mm	Ø9

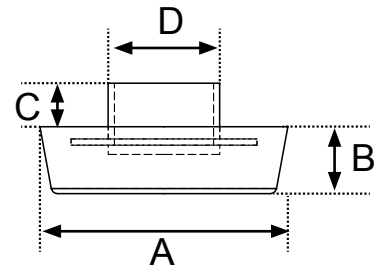

FELT PADS – SELF ADHESIVE

Material: Nonwoven fabric based on synthetic fibers, impregnated with synthetic resin in watery dispersion in order to make it solid & durable, combined with a high quality hot-melt adhesive. Available in black, white & brown.

Application: Self adhesive in round or square shape. To be used to avoid scratches on the floor.

Tip: Avoid using the felt pad for at least 24 hours after mounting to guarantee maximum adhesion.

Item - number	Color	A diameter	B height
#10.50.005	Black	Ø10 mm	1,5mm
#10.50.010	Brown	Ø16 mm	3,5 mm
#10.50.021	Brown	Ø20 mm	3,5 mm
#10.50.030	White	Ø20 mm	3,5 mm
#10.50.031	Black	Ø20 mm	3,5 mm
#10.50.035	Brown	Ø22 mm	3,5 mm
#10.50.040	Brown	Ø28 mm	3,5 mm
#10.50.041	White	Ø28 mm	3,5 mm
#10.50.060	Brown	Ø38 mm	3,5 mm
#10.50.061	Black	Ø38 mm	3,5 mm
#10.50.062	Black	Ø40 mm	3,5 mm
#10.50.073	Black	Ø55 mm	3,5 mm
#10.50.079	Black	Ø80 mm	3,5 mm
#10.50.088	Black	70 x 70 mm	1,5 mm
#10.50.093	White	10 x 130 mm	3,5 mm

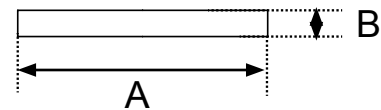

*Other sizes and colors on request.

BUMBER DISCS – SELF ADHESIVE

Material: PVC, transparent color.

Application: Self adhesive bumpers are the ideal solution to avoid scratching surfaces, prevent objects from skidding or vibrating, cushioning the closing of doors and drawers & equalizing height differences.

Tip: Avoid using the bumper discs for at least 24 hours after mounting to guarantee maximum adhesion.



Item - number	Color	A diameter	B height
# 10.39.010	Transparent	Ø7	1,5 mm
# 10.39.015	Transparent	Ø8	1,6 mm
# 10.39.020	Transparent	Ø10	1,5 mm
# 10.39.030	Transparent	Ø10	3,0 mm
# 10.39.040	Transparent	Ø13	4,0 mm

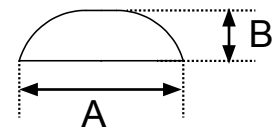

SUCTION PADS W/HOLLOW PIN

Material: PVC, transparent color.

Application: For glass table tops.
Hollow pin.



Item - number	A diameter	B height	C height	D diameter
# 10.38.210	Ø15	10 mm	4 mm	Ø6
# 10.38.220	Ø20	8,5 mm	6,5 mm	Ø6

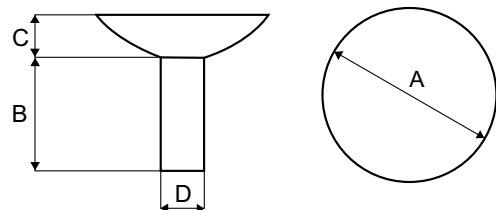

SUCTION PADS W/BALL PIN

Material: PVC, transparent color.

Application: For glass table tops.
Ball pin.



Item - number	A diameter	B height	C height	D diameter
# 10.38.310	Ø20	10 mm	4 mm	Ø6
# 10.38.312	Ø30	13 mm	5 mm	Ø8

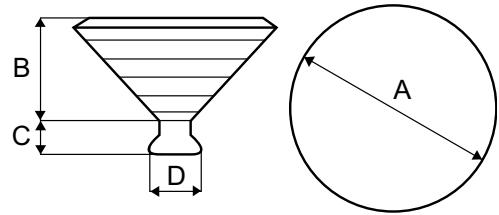

SUCTION PAD/BUMBER

Material: PVC, transparent color.

Application: For glass table tops.

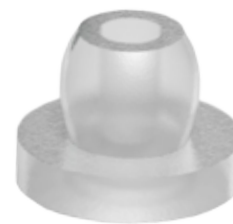

Item - number	D diameter	H height	h height	d diameter
# 10.38.010	Ø8	8 mm	6 mm	4 mm
# 10.38.015	Ø14	10 mm	7 mm	8 mm

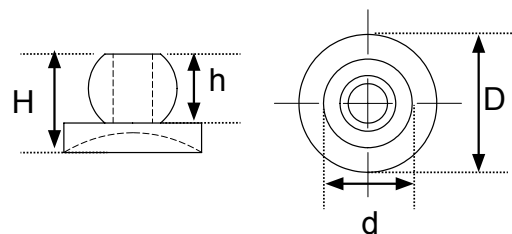

NYLON WASHERS

Material: Polyamid (PA), natural.

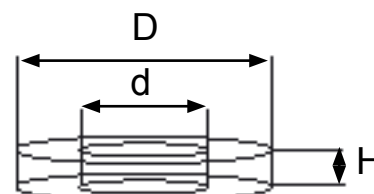

Item - number	D diameter	d diameter	H height
#12.13.455	6 mm	2,5 mm	0,5 mm
#12.13.456	8 mm	4,3 mm	1,5 mm
#12.13.458	13 mm	8,6 mm	2 mm
#12.13.460	17 mm	8,6 mm	2 mm
#12.13.461	17 mm	8,4 mm	1,5 mm
#12.13.470	20 mm	10,5 mm	2 mm
#12.13.471	20 mm	13 mm	2 mm
#12.13.475	20 mm	10,5 mm	2,5 mm
#12.13.476	20 mm	10,5 mm	2,5 mm
#12.13.480	24 mm	13 mm	2,5 mm
#12.13.500	30 mm	17 mm	3 mm

*Other sizes and colors on request.

Minimum quantity: 1000 pcs

DISTANCE SPACERS

Material: Polyethylene (PE), black or white.

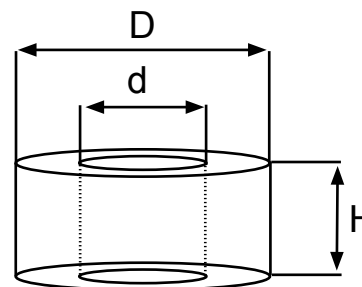

Item - number	Color	D diameter	d diameter	H height
#12.13.555	Black	20 mm	5,3 mm	20 mm
#12.13.556	Black	20 mm	5,3 mm	22,5 mm
#12.13.536	Black	20 mm	6,0 mm	10 mm
#12.13.503	Black	20 mm	6,3 mm	3 mm
#12.13.508	Black	20 mm	6,3 mm	7,5 mm
#12.13.533	Black	20 mm	8,4 mm	10 mm
#12.13.538	Black	20 mm	8,4 mm	12,5 mm
#12.13.501	Black	20 mm	10,5 mm	3 mm
#12.13.507	Black	20 mm	10,5 mm	6 mm
#12.13.553	Black	20 mm	10,5 mm	20 mm
#12.13.670	White	30 mm	6,3 mm	10 mm
#12.13.554	Black	40 mm	10,5 mm	20 mm

*Other sizes and colors on request.

Minimum quantity: 1000 pcs

INSERT GLIDES F/RECTANGULAR TUBES

Material: Polyethylene (PE), black.

Application: For rectangular tubes.



Item - number	Color	D diameter	S shaft	H height
#10.04.090	Black	30 x 20 mm	14 mm	5,0 mm
#10.04.110	Black	35 x 20 mm	13,6 mm	5,1 mm
#10.04.120	Black	35 x 25 mm	13,5 mm	4,6 mm
#10.04.160	Black	40 x 20 mm	13,9 mm	4,6 mm
#10.04.170	Black	40 x 25 mm	11,7 mm	4,8 mm
#10.04.230	Black	50 x 25 mm	12,2 mm	5,3 mm
#10.04.240	Black	50 x 30 mm	13,6 mm	4,6 mm
#10.04.250	Black	50 x 40 mm	12 mm	5,3 mm
#10.04.260	Black	60 x 20 mm	14,2 mm	4,9 mm
#10.04.270	Black	60 x 30 mm	13,7 mm	5,0 mm
#10.04.310	Black	80 x 30 mm	17,8 mm	5,6 mm

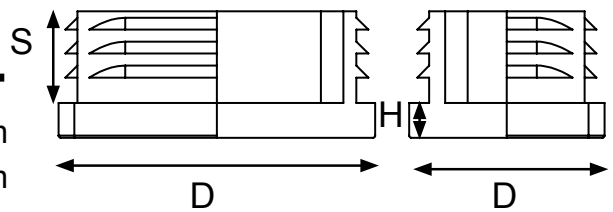

*Minimum quantity: 1000 pcs

Other sizes & colors on request.

INSERT GLIDES F/SQUARE TUBES

Material: Polyethylene (PE), black or white.

Application: For square tubes.



Item - number	Color	D diameter	S shaft	H height
#10.03.010	Black	12 x 12 mm	11,6 mm	4,0 mm
#10.03.020	Black	16 x 16 mm	12 mm	5,0 mm
#10.03.030	Black	18 x 18 mm	11 mm	5,0 mm
#10.03.050	Black	20 x 20 mm	12 mm	5,0 mm
#10.03.051	White	20 x 20 mm	12 mm	5,0 mm
#10.03.040	Black	22 x 22 mm	14 mm	5,0 mm
#10.03.060	Black	25 x 25 mm	13,5 mm	5,0 mm
#10.03.061	White	25 x 25 mm	13,5 mm	5,0 mm
#10.03.070	Black	30 x 30 mm	13,5 mm	5,0 mm
#10.03.080	Black	40 x 40 mm	14 mm	5,0 mm
#10.03.090	Black	50 x 50 mm	19 mm	5,0 mm
#10.03.100	Black	60 x 60 mm	19 mm	4,0 mm

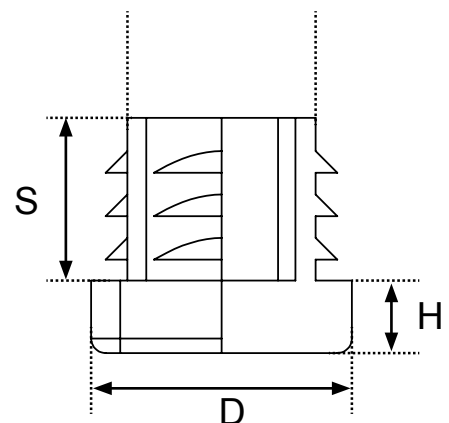

*Minimum quantity: 1000 pcs

Other sizes & colors on request.

INSERT GLIDES F/ROUND TUBES

Material: Polyethylene (PE), black or white.

Application: For round tubes.



Item - number	Color	D diameter	S shaft	H height
#10.02.030	Black	Ø14 mm	9,3 mm	4,0 mm
#10.02.040	Black	Ø15 mm	9,6 mm	4,0 mm
#10.02.070	Black	Ø19 mm	19 mm	4,1 mm
#10.02.080	Black	Ø20 mm	12 mm	4,0 mm
#10.02.090	Black	Ø22 mm	11,8 mm	4,0 mm
#10.02.100	Black	Ø25 mm	11,8 mm	5,0 mm
#10.02.101	White	Ø25 mm	11,8 mm	5,0 mm
#10.02.120	Black	Ø28 mm	14 mm	5,0 mm
#10.02.130	Black	Ø30 mm	14 mm	5,0 mm
#10.02.140	Black	Ø32 mm	14,5 mm	5,0 mm
#10.02.160	Black	Ø35 mm	14,3 mm	5,0 mm
#10.02.185	Black	Ø40 mm	11,7 mm	5,0 mm
#10.02.186	Black	Ø42 mm	11,5 mm	5,0 mm
#10.02.200	Black	Ø50 mm	11,7 mm	5,2 mm

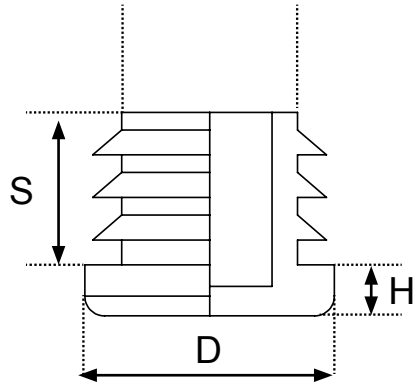

*Minimum quantity: 1000 pcs

Other sizes & colors on request.

INSERT GLIDE F/ OVAL TUBES

Material: Polyethylene (PE), black.

Application: For oval tubes.



Item - number	Color	D diameter	S shaft	H height
#10.02.400	Black	20 x 10 mm	10,5 mm	3,0 mm
#10.02.410	Black	25 x 12 mm	10,5 mm	3,0 mm
#10.02.420	Black	30 x 15 mm	16 mm	2,9 mm
#10.02.440	Black	35 x 20 mm	11,9 mm	5,3 mm
#10.02.450	Black	38 x 20 mm	11,3 mm	4,9 mm
#10.02.460	Black	40 x 20 mm	11,5 mm	4,8 mm
#10.02.480	Black	48 x 20 mm	11,5 mm	4,8 mm
#10.02.490	Black	50 x 20 mm	11,5 mm	4,8 mm

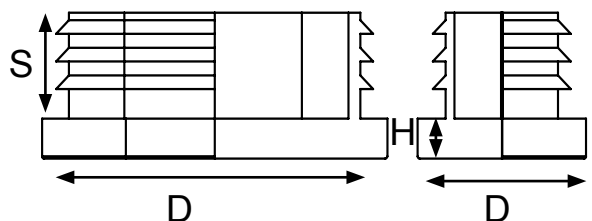

*Minimum quantity: 1000 pcs

Other sizes & colors on request.

INSERT GLIDES W/10 DG ANGLE - F/SQUARE & RECTANGULAR TUBES

Material: Polyethylene (PE), black.

Application: For square and rectangular tubes with 10 degree angle.



Item - number	Color	D diameter	S shaft	H height
#10.05.010	Black	15 x 15 mm	11,5 mm	7,2 mm
#10.05.020	Black	16 x 16 mm	12 mm	7 mm
#10.05.030	Black	18 x 18 mm	12 mm	7,8 mm
#10.05.040	Black	20 x 20 mm	12 mm	8 mm
#10.05.050	Black	20 x 15 mm	12 mm	9,3 mm
#10.05.060	Black	25 x 15 mm	12 mm	7 mm
#10.05.070	Black	25 x 25 mm	14 mm	8,5 mm
#10.05.080	Black	30 x 15 mm	12 mm	8,3 mm
#10.05.090	Black	30 x 20 mm	14,5 mm	8,5 mm

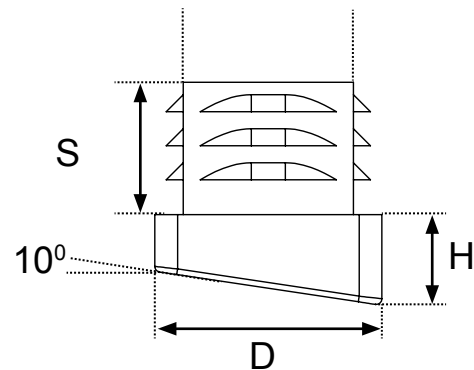

*Minimum quantity: 1000 pcs

Other sizes & colors on request.

INSERT GLIDES W/METAL THREAD - F/ROUND TUBES

Material: Polyamid (PA), black.

Application: With metal thread/hex nut.
For round tubes.



Item - number	Color	D diameter	T thread	S shaft	H height
#10.06.130	Black	Ø25 mm	M8	7 mm	25 mm
#10.06.135	Black	Ø25 mm	M8	5 mm	33,5 mm
#10.06.200	Black	Ø28 mm	M8	5 mm	33,5 mm
#10.06.350	Black	Ø50 mm	M10	8 mm	25 mm

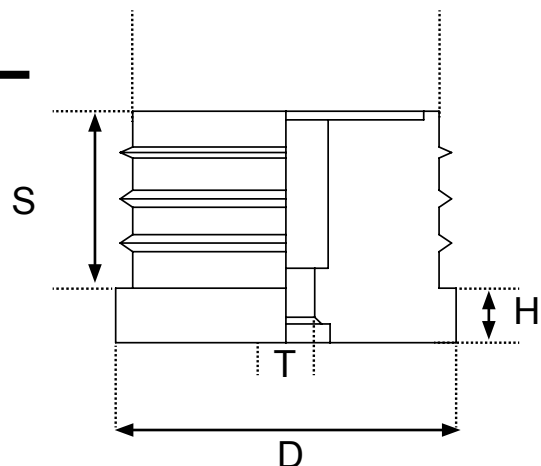

*Minimum quantity: 1000 pcs

Other sizes & colors on request.

INSERT GLIDES W/METAL THREAD - F/SQUARE TUBES

Material: Polyethylene (PE), black.

Application: With metal thread/hex nut.
For square tubes.



Item - number	Color	D diameter	T thread	S shaft	H height
#10.07.065	Black	20 x 20 mm	M8	14,2 mm	6 mm
#10.07.080	Black	25 x 25 mm	M8	13,6 mm	7 mm
#10.07.081	Black	30 x 30 mm	M10	12,8 mm	8 mm
#10.07.082	Black	40 x 40 mm	M10	13,2 mm	8 mm

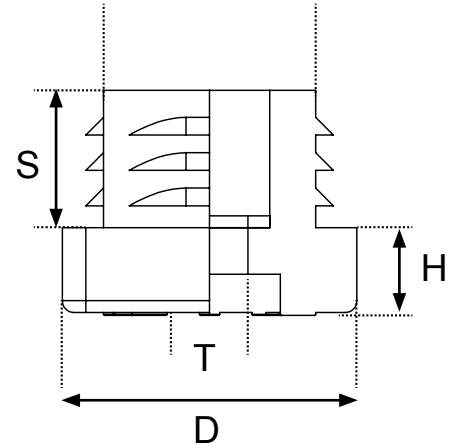

*Minimum quantity: 1000 pcs

Other sizes & colors on request.

PLASTIC CAPS F/ROUND TUBES

Material: Polyethylene (PE), black or white & PVC, black.

Application: For round tubes.

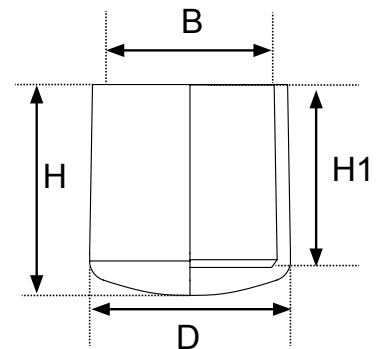

Item - number	Color	Material	D diameter	B diameter	H height	H1 height
#10.01.010	Black	PE	Ø10 mm	Ø13,4 mm	14,6 mm	12,1mm
#10.01.020	Black	PE	Ø13 mm	Ø16,5 mm	18 mm	14 mm
#10.01.030	Black	PE	Ø16 mm	Ø19,7 mm	21,2 mm	17 mm
#10.01.040	Black	PE	Ø18 mm	Ø22,3 mm	23,2 mm	19,2 mm
#10.01.050	Black	PE	Ø20 mm	Ø24,2 mm	23,3 mm	18,9 mm
#10.01.060	Black	PE	Ø22 mm	Ø27,6 mm	24,1 mm	20,1 mm
#10.01.070	Black	PE	Ø25 mm	Ø28,1 mm	30,6 mm	24,8 mm
#10.01.071	White	PE	Ø25 mm	Ø28,1 mm	30,6 mm	24,8 mm
#10.01.080	Black	PE	Ø28 mm	Ø32,8 mm	28,8 mm	23,9 mm
#10.01.090	Black	PVC	Ø32 mm	Ø36 mm	30,8 mm	25,5 mm
#10.01.100	Black	PVC	Ø35 mm	Ø39 mm	31,2 mm	25 mm
#10.01.120	Black	PVC	Ø42 mm	Ø46 mm	33 mm	24 mm

*Minimum quantity: 1000 pcs

Other sizes & colors on request.

TUBE SLIDES W/FIXATION PIN

Material: Polyethylene (PE), black.

Application: For round tubes with Ø5,7 mm. fixation pin (d).



Item - number	Ø tube	L length	B width	H height	S thickness
#10.34.010	Ø18-20 mm	28,5 mm	20 mm	18 mm	4 mm
#10.34.020	Ø20-22 mm	29 mm	22 mm	20 mm	4 mm
#10.34.030	Ø22-25 mm	43,5 mm	23,5 mm	21,5 mm	4 mm
#10.34.040	Ø28-30 mm	43 mm	28,5 mm	24,5 mm	4 mm
#10.34.050	Ø30-32 mm	43 mm	29,5 mm	26 mm	4 mm
#10.34.060	Ø32-35 mm	42,5 mm	30 mm	26,5 mm	4 mm

*Minimum quantity: 1000 pcs

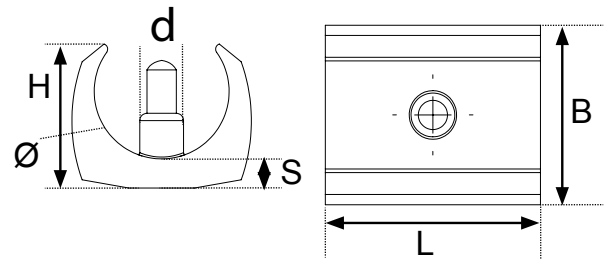

TUBE SLIDES - SCREW-ON

Material: Polyethylene (PE), black.

Application: For round tubes. With screw holes for fixing.

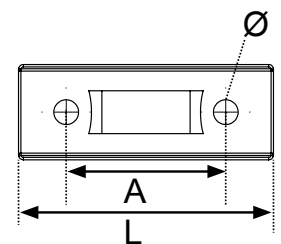
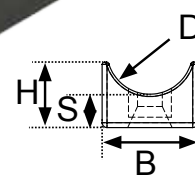

Item - number	D tube	L length	B width	H height	S thickness	Ø screw	A distance
#10.35.010	Ø18-22 mm	53,5 mm	19,8 mm	13,6 mm	7 mm	2 x Ø5,2 mm	33,5 mm
#10.35.020	Ø22-25 mm	49,8 mm	23 mm	10,7 mm	7 mm	1 x Ø5,8 mm	In centre
#10.35.030	Ø28-30 mm	44,8 mm	24,8 mm	11,8 mm	7,7 mm	2 x Ø5,2 mm	22,5 mm
#10.35.040	Ø40 mm	49,8 mm	23 mm	10 mm	6,3 mm	1 x Ø5,5 mm	In centre
#10.35.050	Ø45 mm	46,5 mm	45,8 mm	17,8 mm	7,8 mm	2 x Ø6 mm	22,5 mm

*Minimum quantity: 1000 pcs

**TUBE SLIDES F/CURVED TUBES
- SCREW-ON**

Material: Polyethylene (PE), black.

Application: For curved round tubes.
With screw holes for fixing.



Item - number	D tube	L length	B width	H height	h height	R radius	A distance	A1 distance
#10.36.010	Ø 22 mm	71 mm	23 mm	30,5 mm	6,5 mm	90	9,5 mm	42,3 mm
#10.36.015	Ø 25 mm	72,5 mm	30 mm	30,2 mm	8,3 mm	80	9,5 mm	42,3 mm
#10.36.020	Ø 32 mm	75 mm	32,5 mm	30 mm	8,3 mm	96	12 mm	28 mm
#10.36.025	Ø 38 mm	75 mm	32 mm	30 mm	8,3 mm	96	12 mm	28 mm

*Minimum quantity: 1000 pcs

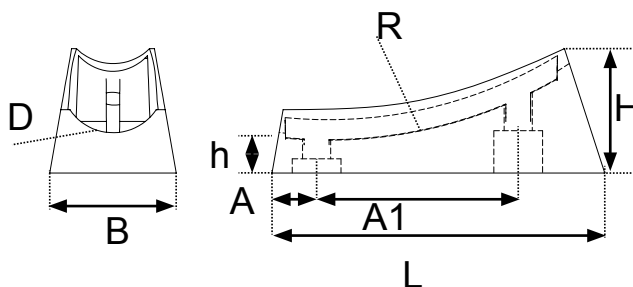

A series of horizontal dotted lines spanning the width of the page, intended for handwritten notes.



- high quality furniture fittings

Item No.: 99.00.032

04.09.2012

SISO A/S

Mileparken 11 Phone: (+45) 45 830 900
DK - 2740 Skovlunde (Copenhagen) Fax: (+45) 45 830 444
Denmark E-mail: siso@siso.dk Web: www.siso.dk